



SCTeci Ethernet Control Interface

Instruction Manual

 **DRAKE**™ is a trademark of the R.L. Drake Holdings, LLC
DRAKE is a registered trademark of the R.L. Drake Holdings, LLC

2 Caution Statements

WARNING: TO PREVENT FIRE OR ELECTRICAL SHOCK DO NOT EXPOSE TO RAIN OR MOISTURE



A product and cart combination should be moved with care. Quick stops, excessive force and uneven surfaces may cause the product and cart combination to overturn.



The lightning flash with arrow head symbol, within an equilateral triangle, is intended to alert the user to the presence of uninsulated "dangerous voltage" within the product's enclosure that may be of sufficient magnitude to constitute a risk of electric shock to persons.



The exclamation point within an equilateral triangle is intended to alert the user to the presence of important operating and maintenance (servicing) instructions in the literature accompanying the product.

WARNING: TO REDUCE THE RISK OF FIRE OR ELECTRIC SHOCK, DO NOT EXPOSE THIS PRODUCT TO RAIN OR MOISTURE.
DO NOT OPEN THE CABINET, REFER SERVICING TO QUALIFIED PERSONNEL ONLY.

CAUTION: TO PREVENT ELECTRIC SHOCK, DO NOT USE THIS (POLARIZED) PLUG WITH AN EXTENSION CORD RECEPTACLE OR OTHER OUTLET UNLESS THE BLADES CAN BE FULLY INSERTED TO PREVENT BLADE EXPOSURE.

ATTENTION: POUR PREVENIR LES CHOCS ELECTRIQUES, NE PAS UTILISER CETTE FICHE POLARISEE AVEC UN PROLONGATEUR, UNE PRISE DE COURANT OU UNE AUTRE SORTIE DE COURANT, SAUF SI LES LAMES PEUVENT ETRE INSEREES A FOND SANS EN LAISSER AUCUNE PARTIE A DECOUVERT.

- 1. Read Instructions**—All the safety and operating instructions should be read before the product is operated.
- 2. Retain Instructions**—The safety and operating instructions should be retained for future reference.
- 3. Heed Warnings**—All warnings on the product and in the operating instructions should be adhered to.
- 4. Follow Instructions**—All operating and use instructions should be followed.
- 5. Cleaning**—Unplug this product from the wall outlet before cleaning. Do not use liquid cleaners or aerosol cleansers. Use a damp cloth for cleaning.
- 6. Attachments**—Do not use attachments that are not recommended by the product manufacturer as they may cause hazards.
- 7. Water and Moisture**—Do not use this product near water—for example, near a bathtub, wash bowl, kitchen sink or laundry tub; in a wet basement; or near a swimming pool; and the like.
- 8. Accessories**—Do not place this product on an unstable cart, stand, tripod, bracket, or table. The product may fall, causing serious injury to a child or adult, and serious damage to the product. Use only with a cart, stand, tripod, bracket, or table recommended by the manufacturer, or sold with the product. Any mounting of the product should follow the manufacturer's instructions, and should use a mounting accessory recommended by the manufacturer.
- 9.** A product and cart combination should be moved with care. Quick stops, excessive force, and uneven surfaces may cause the product and cart combination to overturn.
- 10. Ventilation**—Slots and openings in the cabinet are provided for ventilation and to ensure reliable operation of the product and to protect it from overheating, and these openings must not be blocked or covered. The openings should never be blocked by placing the product on a bed, sofa, rug, or similar surface. This product should not be placed in a built-in installation such as bookcase or rack unless proper ventilation is provided or the manufacturer's instructions have been adhered to.
- 11. Power Sources**—This product should be operated only from the type of power source indicated on the marking label. If you are not sure of the type of power supplied to your home, consult your product dealer or local power company. For products intended to operate from battery power, or other sources, refer to the operating instructions.
- 12. Grounding or Polarization**—This product may be equipped with a polarized alternating-current line plug (a plug having one blade wider than the other). This plug will fit into the power outlet only one way. This is a safety feature. If you are unable to insert the plug fully into the outlet, try reversing the plug. If the plug should still fail to fit, contact your electrician to replace your obsolete outlet. Do not defeat the safety purpose of the polarized plug. Alternate Warnings—If this product is equipped with a three-wire grounding-type plug, a plug having a third (grounding) pin, the plug will only fit into a grounding-type power outlet. This is a safety feature. If you are unable to insert the plug into the outlet, contact your electrician to replace your obsolete outlet. Do not defeat the safety purpose of the grounding-type plug.
- 12 a. Mise à la terre ou Polarisation**—Cet appareil est équipé avec un cordon d'alimentation à trois fils. Il est à brancher sur une prise ayant un connecteur à la terre. Assurez-vous que la connection à la terre ne manque pas.
- 13. Power-Cord Protection**—Power-supply cords should be routed so that they are not likely to be walked on or pinched by items placed upon or against them, paying particular attention to cords at plugs, convenience receptacles, and the point where they exit from the product.

- 14. Outdoor Antenna Grounding**—If an outside antenna or cable system is connected to the product, be sure the antenna or cable system is grounded so as to provide some protection against voltage surges and built-up static charges. Article 810 of the National Electrical Code, ANSI/NFPA 70, provides information with regard to proper grounding of the mast and supporting structure, grounding of the lead-in wire to an antenna discharge unit, size of grounding conductors, location of antenna-discharge unit, connection to grounding electrodes, and requirements for the grounding electrode. See Figure A.
- 15. Lightning**—For added protection for this product during a lightning storm, or when it is left unattended and unused for long periods of time, unplug it from the wall outlet and disconnect the antenna or cable system. This will prevent damage to the product due to lightning and power-line surges.
- 16. Power Lines**—An outside antenna system should not be located in the vicinity of overhead power lines, other electric light or power circuits, where it can fall into such power lines or circuits. When installing an outside antenna system, extreme care should be taken to keep from touching such power lines or circuits as contact with them may be fatal.
- 17. Overloading**—Do not overload wall outlets, extension cords, or integral convenience receptacles as this can result in a risk of fire or electric shock.
- 18. Object and Liquid Entry**—Never push objects of any kind into this product through openings as they may touch dangerous voltage points or short-out parts that could result in a fire or electric shock. Never spill liquid of any kind on the product.
- 19. Servicing**—Do not attempt to service this product yourself as opening or removing covers may expose you to dangerous voltage or other hazards. Refer all servicing to qualified service personnel.
- 20. Damage Requiring Service**—Unplug this product from the wall outlet and refer servicing to qualified service personnel under the following conditions:
 - a. When the power-supply cord or plug is damaged,
 - b. If liquid has been spilled, or objects have fallen into the product,
 - c. If the product has been exposed to rain or water,
 - d. If the product does not operate normally by following the operating instructions. Adjust only those controls that are covered by the operating instructions as an improper adjustment of other controls may result in damage and will often require extensive work by a qualified technician to restore the product to its normal operation,
 - e. If the product has been dropped or damaged in any way, and
 - f. When the product exhibits a distinct change in performance—this indicates a need for service.
- 21. Replacement Parts**—When replacement parts are required, be sure the service technician has used replacement parts specified by the manufacturer or have the same characteristics as the original part. Unauthorized substitutes may result in fire, electric shock or other hazards.
- 22. Safety Check**—Upon completion of any service or repairs to this product, ask the service technician to perform safety checks to determine that the product is in proper operating condition.
- 23. Wall or Ceiling Mounting**—The product should be mounted to a wall or ceiling only as recommended by the manufacturer.
- 24. Heat**—The product should be situated away from heat sources such as radiators, heat registers, stoves, or other products (including amplifiers) that produce heat.

NOTE TO CATV SYSTEM INSTALLERS:
THIS REMINDER IS PROVIDED TO CALL THE CATV SYSTEM INSTALLER'S ATTENTION TO ARTICLE 820 - 40 OF THE NEC THAT PROVIDES GUIDELINES FOR PROPER GROUNDING AND, IN PARTICULAR, SPECIFIES THAT THE CABLE GROUND SHALL BE CONNECTED TO THE GROUNDING SYSTEM OF THE BUILDING, AS CLOSE TO THE POINT OF CABLE ENTRY AS PRACTICAL.

Figure A
Example of antenna grounding as per National Electrical Code, ANSI/NFPA 70

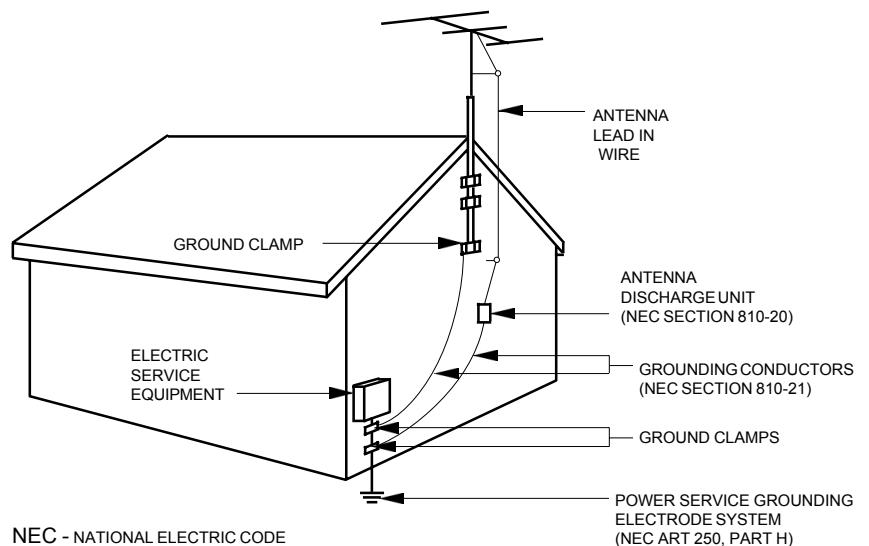

4 Table of Contents / Specifications

TABLE OF CONTENTS

2	Caution Statements	7	Setup and Programming
3	Important Safety Instructions	8	Operation
4	Table of Contents / Specifications	13	Service / If You Need To Call For Help
5	General Description / Installation and Mounting	14	Warranty
6	Front and Rear Panel Controls and Connectors		

SPECIFICATIONS

Functional

Products supported:	SCT860 with PS100. SCT1860, SCT2860, SCT3860, & SCT4860 with PS150 or PS151. DQT861 and MQM861. LBS2250.
Network Interface:	10 Base T LAN or Internet via Ethernet Port, RJ-45.
Output Interface to Headend:	RS232 serial port, DB9.
MAC address:	Each SCTeci has an unique address.
IP address:	User may program a static IP address or may choose it to be assigned by DHCP.
Control security:	System ID and Password, programmable from front panel.
PC software:	No special software required. Displays on HTTP Web Browser such as Microsoft Internet Explorer. Downloads to multiple transcoders in a headend can be enhanced by using the Drake SCT Control software.

Power Requirement 12 VDC nominal @ 250 mA, AC adapter supplied for 120VAC / 60 Hz

Mechanical and Environmental

Size:	19" W x 1.75" H x 4.0 D
Weight:	2.5 lbs.
Operating Temperature:	0 deg C to + 50 deg C ambient

SCTeci Front View

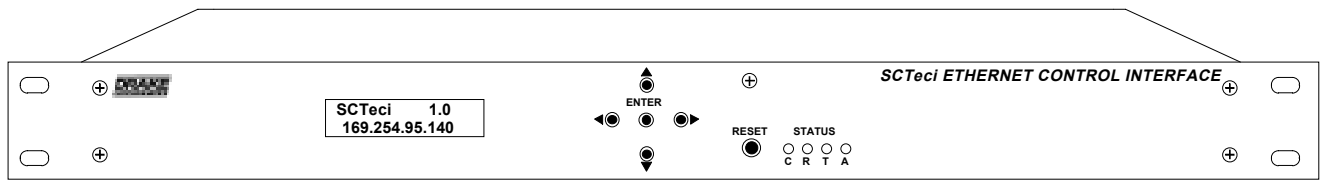

SCTeci Rear View

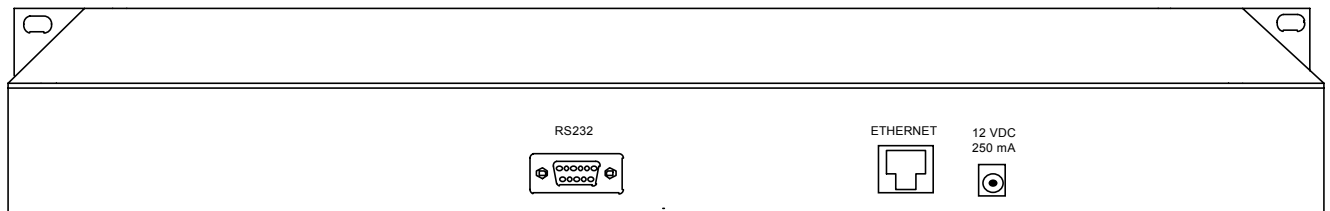

GENERAL DESCRIPTION

The R.L. Drake model SCTeci is a professional quality digital head end Ethernet Control Interface which accepts RS232 serial data from the Drake family of transcoders.

The Drake transcoders supply the RS232 data by means of their required Drake PS100 or PS151 power supplies. The SCTeci then converts this RS232 data to Ethernet format, thus permitting remote observation and control via Internet or LAN. Control of up to 63 SCT860 transcoders and up to 70 SCTx860 transcoders is possible using a single SCTeci.

The SCTeci acts as a server, containing the software needed to provide the required displays on a remote

computer. The remote computer can access the data through the Internet or LAN using a standard web browser such as Internet Explorer, Firefox or Netscape.

The SCTeci is compatible with SCT860, SCT1860, SCT2860, SCT3860, and SCT4860 Transcoders when they are used in conjunction with Drake PS100, PS150, or PS151 Power Supplies.

The SCTeci is contained in a 1.75" x 19" standard rack mounting. It has a front panel LCD display for ease of programming and status monitoring, and is powered by an external 12 volt, 250 mA DC supply.

INSTALLATION AND MOUNTING NOTES

This equipment is designed to be installed in a standard 19" rack. When the unit is mounted above or below other rack mounted equipment, it is recommended that air space of 1 unit high (1.75") be left between the SCTeci and any other rack mounted equipment.

Connect the DC power connector to an appropriate source of 12 VDC with at least 250 mA DC capacity. The SCTeci is always on once the DC power cord is connected to its power source.

6 Front and Rear Panel Controls and Connections

FRONT PANEL CONTROLS AND INDICATORS

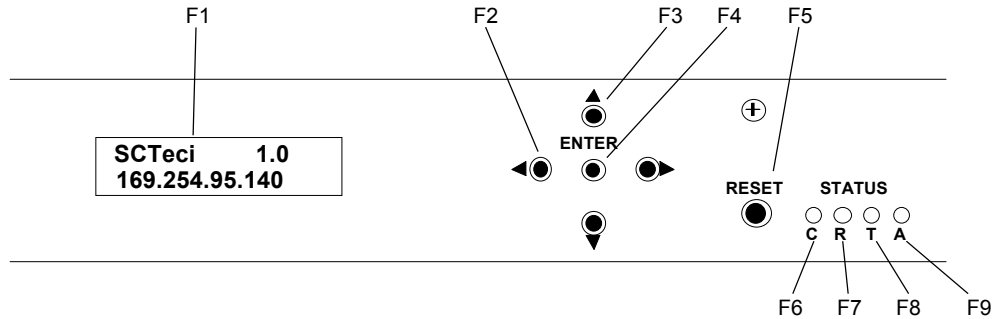

F1, LCD Display – This display presents the selected menu screen and the parameter settings. The backlight in the display is on when power is applied. When connection with a remote computer is established, it will indicate "Link is Active" and will display the IP address.

F2, ◀ Left and ▶ Right Buttons – Use the left and right arrow buttons to navigate from screen to screen to view a parameter setting. These buttons are operational in the view mode or the adjust mode. Using only these buttons will not change any parameter settings. *Once a connection is established with a remote computer, these buttons will have no effect.*

F3, ▲ Up and ▼ Down Buttons – Use the up and down arrow buttons to change the value of a viewed parameter setting. The unit must be in the adjust mode in order for these buttons to become active for changing a parameter setting. If the unit is not in the adjust mode, pressing either button will toggle between the SCTeci version number and IP address, and 'Board Setup' and MAC number. *Once a connection is established with a remote computer, these buttons will have no effect.*

F4, ENTER button – Use the ENTER button to enter the

adjust mode or to save and load a new setting or settings after adjustment. To enter the adjust mode, hold for 2 seconds until a flashing "A" is observed in the upper right hand corner of the display. After entering the adjust mode, momentarily pressing the ENTER button again will load and save any settings that may have been changed using the F2 & F3 buttons.

STATUS LEDs

F5, RESET button -- This button re-initializes the micro-processor. It has the same effect as removing and reapplying power. Use only if abnormal operation is observed.

F6, "C" LED -- Lights continuously when unit is connected to a network.

F7, "R" LED -- Dims when Ethernet packets are being received.

F8, "T" LED -- Dims when Ethernet packets are being sent.

F9, "A" LED -- Flashes continuously when unit is connected to power.

REAR PANEL CONNECTONS

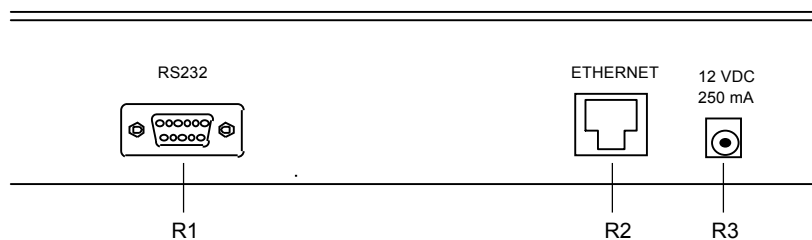

R1, RS232 – This is the RS232 serial connection to the Drake transcoder power supply or supplies. It should be connected to the 'RS232 IN' connector of the transcoder power supply. Multiple power supplies should be "daisy chained" as explained in the transcoder instructions.

R2, ETHERNET – This is the ethernet connector and should be connected to the router, switch, or hub which provides the gateway to the Internet or your LAN.

R3, 12 VDC -- Connect this terminal to a 12 VDC power supply which has at least a 250 mA capacity. The center terminal is positive. The SCTeci will be on as soon as power is applied to this connector.

SCTeci Software Flow Chart

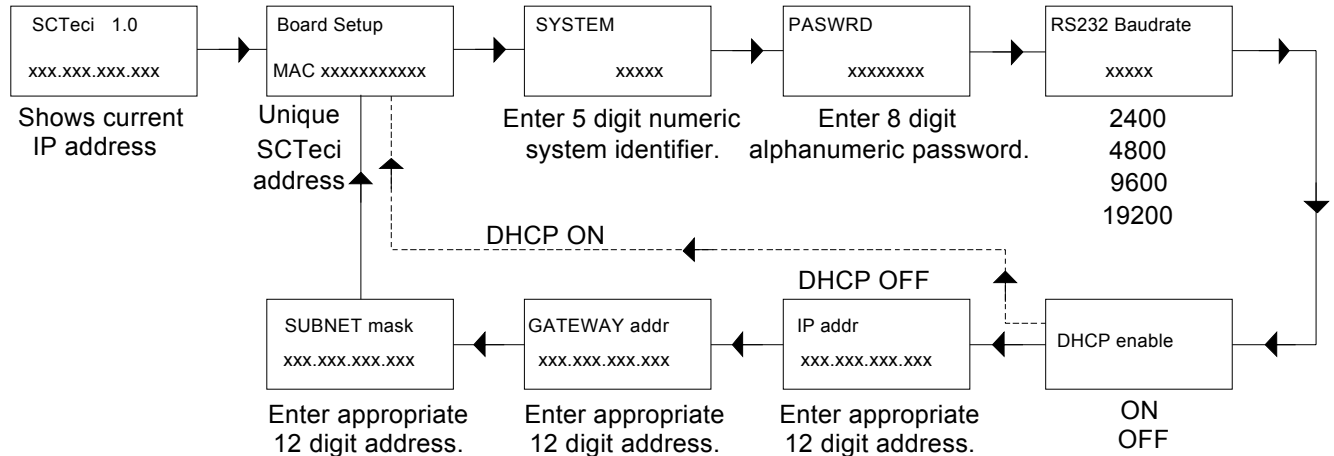

CONNECTIONS & POWER UP

Connect the RS232 connector to the RS232 IN connector of the Drake power supply used to power the Transcoders to be controlled. If more than one power supply is in use in your system, their RS232 connectors should be "daisy chained" together.

Connect the ETHERNET connector to the router, hub, or switch which provides access to the Internet or to the LAN you intend to use.

Connect the 12 VDC connector to an appropriate source of 12 VDC with at least 250 mA DC capacity. The SCTeci will activate as soon as power is supplied.

PROGRAMMING

Programming and viewing of the various setup and operating parameters is accomplished using the front panel back lit, two line, sixteen character wide LCD along with the 4 arrow buttons and the ENTER button. The name of the parameter is on the top line of the display and the setting value is on the bottom line.

To observe a certain parameter setting without intending to change its value, just use the left and right arrow buttons to navigate through the menus shown in the above flow chart. The current setting for each parameter is shown on the bottom line of the display. Note that, depending upon the DHCP enable setting, some screens are not needed and will be skipped.

To make a change in the displayed parameter and its setting, and if this is the initial setup, you will want to enter the 'adjust' mode. To do this, press the ENTER button that is located in the center of the four arrow buttons and hold in for several seconds until a flashing caret (^) is observed in the upper right hand corner of the display.

After you are in the adjust mode press the right arrow key. This will cause an asterisk (*) to appear over one digit of

the parameter to be changed. Use the up and down arrow keys to change each individual digit to the desired value and use the left and right arrow keys to move the asterisk to the next digit to be changed. Note that repeatedly pressing the right arrow key when in the 'adjust' mode will scroll through each changeable parameter one digit at a time. Repeatedly pressing the left arrow button when in the adjust mode will scroll left one digit at a time until the first digit of a given parameter is reached. It will then scroll through each of the changeable parameters without producing an asterisk. Also note that you cannot enter the 'adjust' mode when on a screen that does not have a changeable parameter. i.e.: 'Board Setup' and 'SCTeci /IP number' screens.

When ENTER is pressed, the new settings will be loaded and stored and the unit will exit the 'adjust' mode. You may wish to not press ENTER until you have gone through all screens and settings and then press ENTER to save and load all changes in one step OR you can store just one or several parameters at a time and reenter adjust mode to set the next. Either method is acceptable.

SPECIAL CONSIDERATIONS

IP addr, GATEWAY addr, and SUBNET mask parameters will not allow entries greater than 255. Therefore if you wanted to change a number such as 165 to 225 and first attempted to change the 1 to a 2, you would not be permitted to do so. You would first have to change the 6 to a 2 before changing the 1 to a 2.

SYSTEM can be any number between 11111 and 99999 *excluding zeros*. Each digit scrolls from 1 to 9, no 0.

PASWRD can be any eight alphanumeric characters, including upper and lower case letters, numbers, and punctuation - the SCTeci password. This is not to be confused with the transcoder password, if used.

RS232 Baudrate: Make sure that the RS232 baud rate that you select agrees with the RS232 baud rate of all Drake power supplies to which the SCTeci is connected.

Once the SCTeci has been programmed with the desired IP address, System ID, and password, it can be accessed from any remote location on your LAN (Local Area Network) or the Internet using a PC with a standard web browser such as Internet Explorer, Netscape, or Firefox.

Establishing a Link

To obtain remote access, proceed as follows.

1) Enter the IP address on the address line of your browser and press ENTER. This will bring up a log-on screen as shown below.

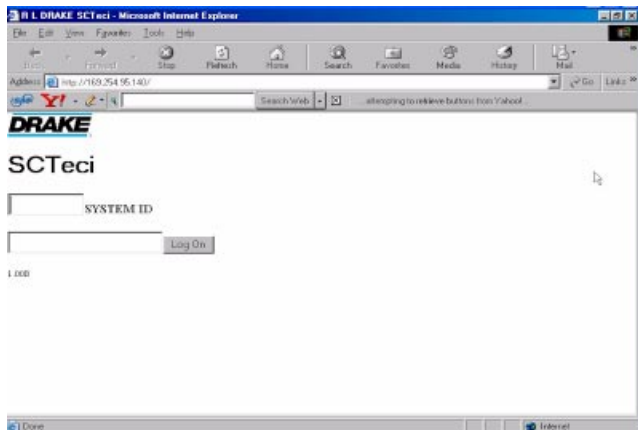

- 2) Navigate to the SYSTEM ID window, and type in the SYSTEM ID which you programmed into the SCTeci.
- 3) Navigate to the next window (using TAB or mouse), and type in the password which you programmed into the SCTeci. Skip this step if you do not know the password and only wish to view and do not wish to change any parameters. Password not required to view only.
- 4) When you are finished typing in this information, click on the 'LOG ON' button. This will establish a link with the SCTeci and will produce a screen similar to the one shown below.

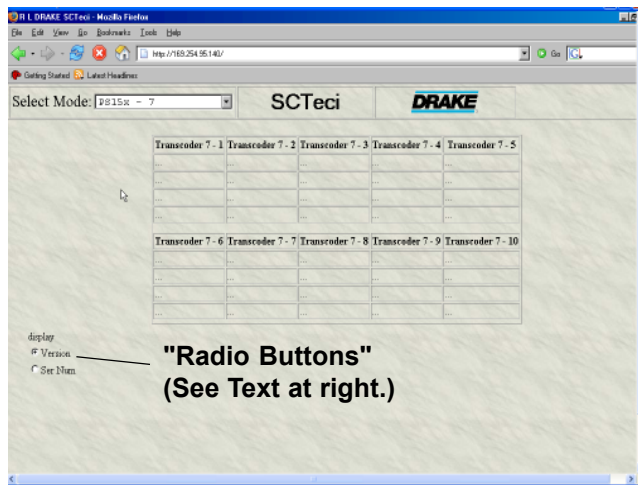

Note that once a link is established, "Link is Active" followed by the SCTeci IP number will appear on the SCTeci display, and all front panel buttons except RESET will be locked out.

Note: Allow ten seconds between stopping or closing one logged on screen and attempting to log on again.

Selecting Desired Information

Notice the Select Mode window appearing at the top of this screen. Clicking on the down arrow on the side of this window will cause a drop down dialog box to appear showing the available options as shown in the following illustration.

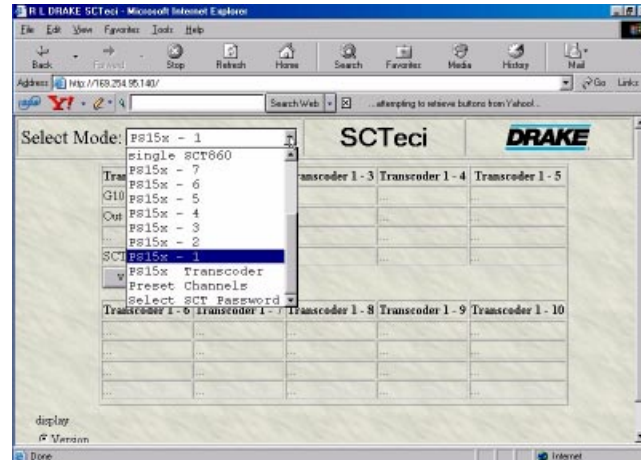

You may select the desired option by moving the mouse cursor over your selection and left clicking once on the one desired.

Displayed Information

Selecting SCT860 1–10 through SCT860 51–60 will produce a table with six rows for each of the ten selected transcoders, as shown in the previous two illustrations. Selecting SCT860 61-63 will produce a table for only three transcoders. The entries for each transcoder will be as follows:

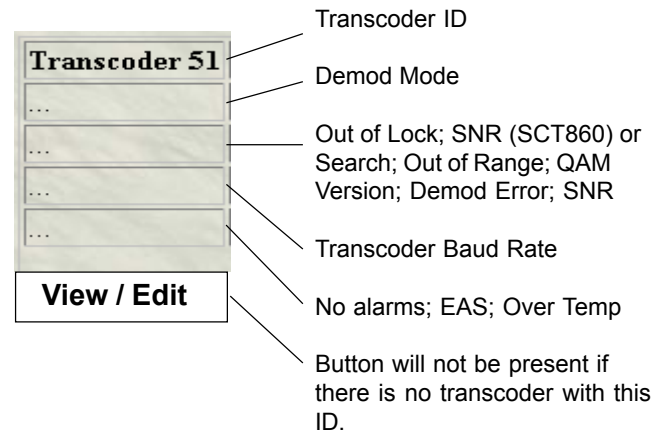

If PS15x – 1 through 7 is selected, the displayed information will be similar. However, row 3 will have slightly different error information, and row 5 will show either the Model and Version numbers, or the serial number, depending on the setting of the radio buttons in the lower left corner of the window. (See illustration at left.)

See note on page 11 if FTP file transfer was used.

No radio buttons will be displayed if SCT860 entries are selected since they do not have internally programmed serial numbers.

MODIFYING TRANSCODER PARAMETERS

To modify parameters of any monitored transcoder, you must first do one of the following:

- 1) From the select mode menu, select 'single SCT860', or 'PS15x Transcoder'. OR
- 2) Select any of the SCT860 or PS15x entries that have active transcoders. Then press the 'View/Edit' button beneath the data for the selected transcoder.

Either of these actions will produce a screen similar to the one shown below which will contain the changeable parameters for the selected transcoder.

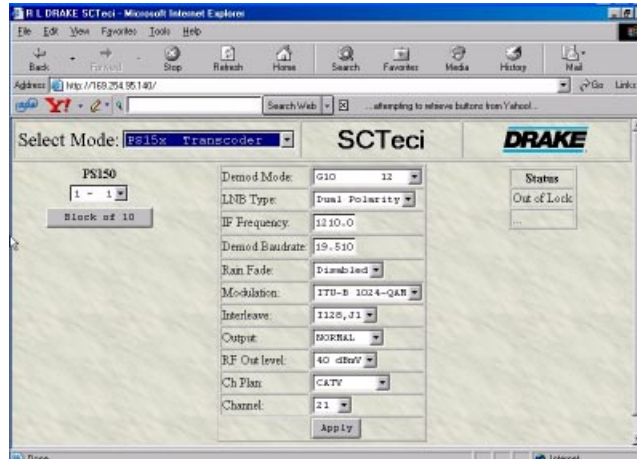

- 1) Pressing the down arrow for a selected parameter will produce a drop down menu which will give the available choices.
- 2) Left click on the desired choice to select it.
- 3) On items which have no down arrow, the desired parameters can be typed in directly. If an illegal entry is typed in, an error message will be displayed.
- 4) Once you have changed all the parameters to your satisfaction, press the 'APPLY' button. This will perform the actual transcoder parameter changes.

The top cell of the 'Status' table on the upper right corner of the display will show one of the following error messages: Search; Out of Lock; Out of range; QAM Version; Demod error; or if there are no errors, signal to noise ratio (SNR).

The bottom cell displays the transcoder baud rate.

The selection box in the upper left hand corner of this window allows selection of the displayed parameters for any other transcoder attached through PS15x power supplies. The 'Block of 10' button will produce a table which will show all 10 transcoders in the group containing the transcoder displayed in the box.

Note that the exact appearance of the screens shown here will vary depending upon the web browser used, and to the PC display resolution selected. In the above window, Internet Explorer V6 was used with a screen resolution of 800 x 600 pixels.

ENTERING OR CHANGING SCT PASSWORD

If the transcoders being accessed have been set to require a password, this SCT password must be entered into the SCTeci. Do not confuse this with the SCTeci PASWRD. Proceed as follows.

- 1) Click on the down arrow on the 'Select Mode:' window, and choose 'Select SCT Password' from the resulting drop down menu. This will produce a screen similar to below.



- 2) Type the desired SCT transcoder password into the box as shown in the above illustration. If the password is already programmed into the SCT, stop here.
- 3) If the password in the SCTs needs entered or changed, someone at the SCT transcoder location must simultaneously hold down the left, center, and right buttons on each SCT860 or PS151 for at least two seconds. This will cause 'LOADING PASSWORD' to appear on the SCT transcoder's display. Do this on each transcoder or power supply that needs the new password loaded. If being remote controlled solely with the SCTeci, a password of 0 should be entered. Factory default setting is 0.
- 4) Then click on the OK button. This will load the new password into the transcoder. 'LOADING PASSWORD' will disappear from the SCT transcoder's display and the new password will be loaded.

PRESET CHANNELS

The preset channels function allows you to add to, modify, or delete the selections that are available in the Demod Mode selection window which appears when programming individual SCTxxxx transcoders. To access this function, select 'Preset Channels' from the Select Mode drop down menu. You will be presented with a screen similar to the following:

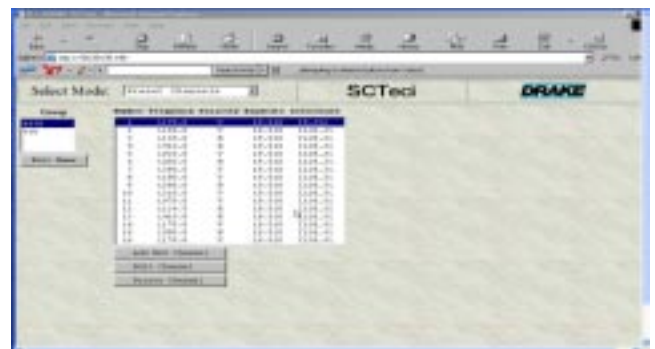

Notice the 'Group' window on the left and the 'Add New Channel', 'Edit Channel', and 'Delete Channel' buttons at the bottom of the channels window.

10 Operation (continued)

Note: Adding, editing, or deleting of preset channels, after the transcoder settings have been stored for a headend, should be done using the SCT Control program software. You can use the browser connection through the SCTeci to make these changes initially, before the settings are downloaded to the transcoders.

Adding a Channel

- 1) To add a channel using the web browser connection, first select the group to which you want to add it. In this case, in the Group window, select either 'HITS' or 'G10'.
- 2) Next, click the 'Add New Channel' button. This will bring up a window similar to the following:

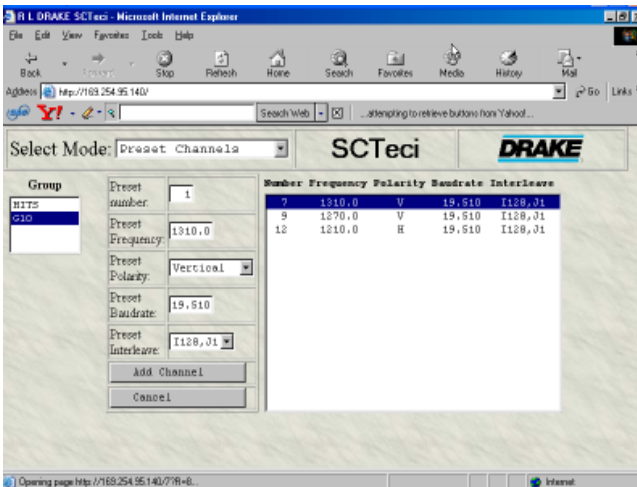

- 3) Proceed through the 'Preset number', 'Preset Frequency', 'Preset Polarity', 'Preset Baudrate', and 'Preset Interleave' boxes and enter the desired parameters for the new channel.
- 4) Take care that you do not use a preset number that is already listed. Then press the 'Add Channel' button to add the new channel to the list.

The new channel will now be added to the 'Preset Channels' list and can be programmed into any SCTxxx transcoder by selecting it from the 'Demod Mode' drop down menu which is available when programming a particular transcoder.

Editing a Channel

- 1) To modify the parameters of a preset channel, select the Group and channel you wish to modify from the 'Preset Channels' screen.
- 2) Press the 'Edit Channel' button, which will bring up a screen similar to the one shown at the top of this column.
- 3) Change the desired parameters.
- 4) When finished, press the 'Modify Channel' button. This will change the parameters of the numbered preset channel.

The modified channel can be programmed into individual transcoders by selecting the modified channel from the 'Demod Mode' list as described above under 'Adding a Channel'.

Deleting a Channel

- 1) From the Preset Channels screen, select the group and channel that you wish to delete.
- 2) Press the 'Delete Channel' button. This will remove the channel from the 'Preset Channels' list.

Editing a Group Name

The names of the groups listed in the 'Group' window of the Preset Channels page can be altered to what ever name the user prefers so long as the revised name does not exceed eight characters. To do so, proceed as follows:

- 1) From the 'Select Mode' window, select 'Preset Channels'.
- 2) Select the group name you wish to modify in the group window and click on the 'Edit Name' button. This will bring up a screen similar to the following.



- 3) Select the group name you wish to modify from the 'Group' window. The selected name will appear in the 'Enter Name' box.
- 4) With the TAB key or mouse, move the cursor to the 'Enter Name' box and type in the new name. Note that if more than eight characters are typed in, the additional characters will be ignored.
- 5) To record the new name, press the 'Change Name' button. This will record the name and change back to the previous screen.

The new name will be observed in the 'Demod Mode:' window the next time any transcoder is selected from the 'Select Mode' window, but will not be observed in an actual transcoder until any parameter for that transcoder is changed by means of the SCTeci.

Three Year Limited Warranty

R.L. DRAKE COMPANY warrants to the original purchaser this product shall be free from defects in material or workmanship for three (3) years from the date of original purchase.

During the warranty period the R.L. DRAKE COMPANY or an authorized Drake service facility will provide, free of charge, both parts and labor necessary to correct defects in material and workmanship. At its option, R.L. DRAKE COMPANY may replace a defective unit.

To obtain such a warranty service, the original purchaser must:

- (1) Retain invoice or original proof of purchase to establish the start of the warranty period.
- (2) Notify the R.L. DRAKE COMPANY or the nearest authorized service facility, as soon as possible after discovery of a possible defect, of:
 - (a) the model and serial number,
 - (b) the identity of the seller and the approximate date of purchase; and
 - (c) A detailed description of the problem, including details on the electrical connection to associated equipment and the list of such equipment.
- (3) Deliver the product to the R.L. DRAKE COMPANY or the nearest authorized service facility, or ship the same in its original container or equivalent, fully insured and shipping charges prepaid.

Correct maintenance, repair, and use are important to obtain proper performance from this product. Therefore carefully read the Instruction Manual. This warranty does not apply to any defect that R.L. DRAKE COMPANY determines is due to:

- (1) Improper maintenance or repair, including the installation of parts or accessories that do not conform to the quality and specifications of the original parts.
- (2) Misuse, abuse, neglect or improper installation.
- (3) Accidental or intentional damage.

All implied warranties, if any, including warranties of merchantability and fitness for a particular purpose, terminate three (3) years from the date of the original purchase.

The foregoing constitutes R.L. DRAKE COMPANY'S entire obligation with respect to this product, and the original purchaser shall have no other remedy and no claim for incidental or consequential damages, losses or expenses. Some states do not allow limitations on how long an implied warranty lasts or do not allow the exclusions or limitation of incidental or consequential damages, so the above limitation and exclusion may not apply to you.

This warranty gives you specific legal rights and you may also have other rights which vary from state to state. This warranty shall be construed under the laws of Ohio.

For Service, contact:

R.L. DRAKE HOLDINGS, LLC
710 Pleasant Valley Drive
Springboro, Ohio 45066 U.S.A.
Customer Service and Parts Telephone: +1 (937) 746-6990
Telefax: +1 (937) 806-1510
World Wide Web Site: <http://www.rldrake.com>



R.L. Drake Holdings, LLC

710 Pleasant Valley Drive
Springboro, Ohio 45066 U.S.A.

Customer Service and Parts Telephone: +1 (937) 746-6990

Telefax: +1 (937) 806-1510

World Wide Web Site: <http://www.rldrake.com>