

The R.L. Drake DDC864 is a low noise downconverter designed for translating digital signals from their off-air or CATV channel to a 44 MHz IF output. The output of the DDC864 can be connected to a DUC series upconverter to place the digital signal on a new output channel.

When the DDC864 is used with the DUC550 or DUC860, all input/output channel combinations are usable except "on channel" conversions.

When the DDC864 is used with the DUC864, "on channel" conversions, (the same input channel on the DCC and output channel on the DUC) are acceptable.

The DDC864 provides low noise figure and low phase noise as well as a flat passband to minimize signal deterioration.

The DDC864 is optimized for use with ATSC 8VSB modulation in a 6 MHz wide channel assignment. The passband is designed for optimized operation with 8VSB signals in an adjacent channel environment. For translation of QAM signals, the Drake model QQP860 is preferred for this task.

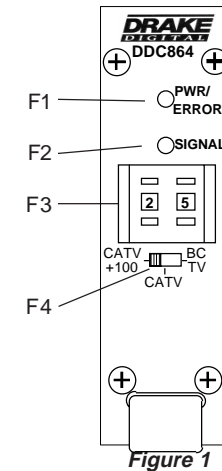

Figure 1

F1 - POWER/ERROR Indicator

Lights when the unit is connected to the required source of DC power via the rear panel DC INPUT connector. A flashing condition indicates an invalid channel setting or other conditions that would cause the unit to operate on an invalid channel. The RF output is switched off for flashing (ERROR) conditions.

F2 - SIGNAL Indicator

Lights when a signal is present.

F3 - Channel Number Switch

Sets the desired operating channel for standard CATV channels 02 through 135 or Broadcast TV channels 02 through 69. See also Item F4 which sets the type of channel (CATV or Broadcast TV) and sets the leading "1" for CATV channels 100 through 135.

F4 - Mode Switch

Sets the type of channel, CATV or Broadcast TV ("BC TV"). The "+100" position of the switch sets a leading "1" for CATV channels 100 through 135. See also Item F3 for setting the channel number.

For example:
Setting for CATV channel "124"-

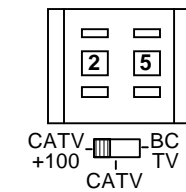

For example:
Setting for CATV channel "75"-

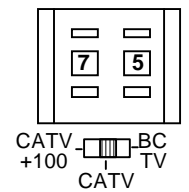

TM is a trademark of the R.L. Drake Company

DRAKE is a registered trademark of the R.L. Drake Company

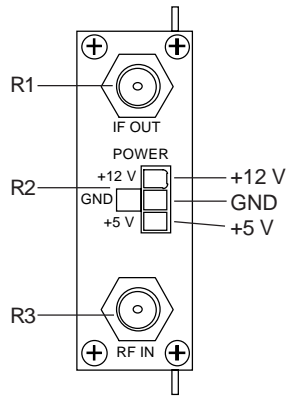

Figure 2

R1 - IF OUTPUT Connector

This is the 44 MHz IF output. The level is +30 dBmV.

R2 - DC INPUT Connector

This 3-pin connector (Male) accepts the appropriate mating DC power cable. Observe proper orientation and wiring.

R3 - RF IN Connector

This is the downconverter RF input from an antenna or CATV feed.

CONNECTIONS AND CONTROLS

All connections to and from each upconverter are made through the rear panel.

DESCRIPTION

Figure 3 shows a typical installation utilizing the Drake DRMM12 rack with 4 DDC864 downconverters, and 4 DUC864 upconverters. A PS8 power supply module is used to power all units.

RACK MOUNTING

Adequate ventilation is very important in multichannel installations. Units should be spaced apart vertically by at least 1.75" wherever possible, and some air movement is mandatory in enclosed rack cabinets. Excessive heat will shorten component life and performance will be degraded without proper cooling.

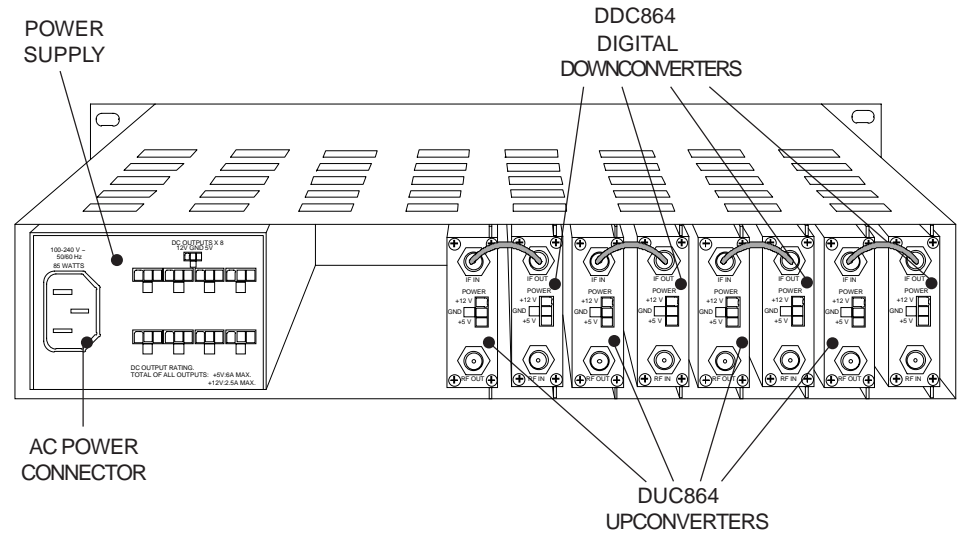



Figure 3

CATV CHANNEL INPUT FREQUENCIES 5

TABLE 1: CATV 

CABLE TV CHANNELS	
Channel Number	Center of Channel
EIA/NCTA Numeric Equivalent	Frequency in MHz
2	57
3	63
4	69
5	79
6	85
95	93
96	99
97	105
98	111
99	117
14	123
15	129
16	135
17	141
18	147
19	153
20	159
21	165
22	171
7	177
8	183
9	189
10	195
11	201
12	207
13	213
23	219
24	225
25	231
26	237
27	243
28	249
29	255
30	261
31	267
32	273
33	279
34	285
35	291
36	297
37	303
38	309
39	315
40	321

CABLE TV CHANNELS	
Channel Number	Center of Channel
EIA/NCTA Numeric Equivalent	Frequency in MHz
41	327
42	333
43	339
44	345
45	351
46	357
47	363
48	369
49	375
50	381
51	387
52	393
53	399
54	405
55	411
56	417
57	423
58	429
59	435
60	441
61	447
62	453
63	459
64	465
65	471
66	477
67	483
68	489
69	495
70	501
71	507
72	513
73	519
74	525
75	531
76	537
77	543
78	549
79	555
80	561
81	567
82	573
83	579
84	585
85	591

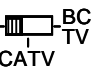
CABLE TV CHANNELS	
Channel Number	Center of Channel
EIA/NCTA Numeric Equivalent	Frequency in MHz
86	597
87	603
88	609
89	615
90	621
91	627
92	633
93	639
94	645
CATV +100 BC TV 	
100	651
101	657
102	663
103	669
104	675
105	681
106	687
107	693
108	699
109	705
110	711
111	717
112	723
113	729
114	735
115	741
116	747
117	753
118	759
119	765
120	771
121	777
122	783
123	789
124	795
125	801
126	807
127	813
128	819
129	825
130	831
131	837
132	843
133	849
134	855
135	861

6 BROADCAST TV CHANNEL INPUT FREQUENCIES

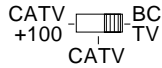
TABLE 2: BC TV 

VHF BROADCAST CHANNELS	
Channel Number	Center of Channel Frequency (MHz)
2	57
3	63
4	69
5	79
6	85
7	177
8	183
9	189
10	195
11	201
12	207
13	213

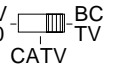
CATV +100 BC TV

UHF BROADCAST CHANNELS	
Channel Number	Center of Channel Frequency (MHz)
14	473
15	479
16	485
17	491
18	497
19	503
20	509
21	515
22	521
23	527
24	533
25	539
26	545
27	551
28	557
29	563
30	569
31	575
32	581
33	587
34	593
35	599
36	605
37	611
38	617
39	623
40	629
41	635
42	641
43	647
44	653
45	659
46	665
47	671
48	677
49	683
50	689
51	695
52	701
53	707
54	713
55	719
56	725
57	731
58	737
59	743
60	749
61	755
62	761
63	767
64	773
65	779
66	785
67	791
68	797
69	803

RF INPUT

Frequency Range: 54 to 864 MHz;
 OFF-AIR channels 2 to 69,
 CATV channels 2 to 135.
 Input level Range: -30 dBmV to +30 dBmV.
 Impedance: 75 Ohms, return loss of 8 dB
 Noise Figure: 10 dB, typical.
 Image Rejection: 55 dB.

Output

IF Frequency: 44 MHz.
 Level: +30 dBmV, ±1 dB.
 Impedance: 75 Ohms, return loss of 20 dB
 Frequency Stability: ±5 PPM.
 Channel Bandwidth: 6 MHz SAW filtered.
 SSB Phase Noise: -95 dBc @ 10 kHz offset.
 Amplitude Flatness
 (6 MHz Channel): ±3 dB over center 5 MHz
 C/N: 50 dB with +10 dBmV input level.
 MER with 8VSB: >35 dB (equalized).

GENERAL

DC Power Input: +12 V ±5% @ 275 mA .
 +5 V ±5% @ 275 mA.
 Operating Temperature: 0°C to +50°C ambient.
 Size: 1" W x 3.5" H x 9.25" D. (2.5 cm) W x (8.9 cm) H x (23.5 cm) D.
 Weight: 14.5 oz. (0.41 Kg).

Specifications subject to change without notice or obligation.

THREE YEAR LIMITED WARRANTY

R.L. DRAKE COMPANY warrants to the original purchaser this product shall be free from defects in material or workmanship for three (3) years from the date of original purchase.

During the warranty period the R.L. DRAKE COMPANY or an authorized Drake service facility will provide, free of charge, both parts and labor necessary to correct defects in material and workmanship. At its option, R.L. DRAKE COMPANY may replace a defective unit.

To obtain such warranty service, the original purchaser must:

- (1)** Retain invoice or original proof of purchase to establish the start of the warranty period.
- (2)** Notify the R.L. DRAKE COMPANY or the nearest authorized service facility, as soon as possible after discovery of a possible defect, of:
 - (a) the model and serial number,
 - (b) the identity of the seller and the approximate date of purchase; and
 - (c) A detailed description of the problem, including details on the electrical connection to associated equipment and the list of such equipment.
- (3)** Deliver the product to the R.L. DRAKE COMPANY or the nearest authorized service facility, or ship the same in its original container or equivalent, fully insured and shipping charges prepaid.

Correct maintenance, repair, and use are necessary to obtain proper performance from this product. Therefore carefully read the Instruction Manual. This warranty does not apply to any defect that R.L. DRAKE COMPANY determines is due to:

- (1)** Improper maintenance or repair, including the installation of parts or accessories that do not conform to the quality and specifications of the original parts.
- (2)** Misuse, abuse, neglect or improper installation.
- (3)** Accidental or intentional damage.

All implied warranties, if any, including warranties of merchantability and fitness for a particular purpose, terminate three (3) years from the date of the original purchase.

The foregoing constitutes R.L. DRAKE COMPANY'S entire obligation with respect to this product, and the original purchaser shall have no other remedy and no claim for incidental or consequential damages, losses or expenses. Some states do not allow limitations on how long an implied warranty lasts or do not allow the exclusions or limitation of incidental or consequential damages, so the above limitation and exclusion may not apply to you.

This warranty gives you specific legal rights and you may also have other rights which vary from state to state. This warranty shall be construed under the laws of Ohio.



R.L. DRAKE COMPANY
 230 INDUSTRIAL DRIVE
 FRANKLIN, OHIO 45005 U.S.A.
CUSTOMER SERVICE AND PARTS TELEPHONE: +1 (937) 746-6990
TELEFAX: +1 (937) 806-1576
WORLD WIDE WEB SITE: <http://www.rldrake.com>

THREE YEAR LIMITED WARRANTY

R.L. DRAKE COMPANY warrants to the original purchaser this product shall be free from defects in material or workmanship for three (3) years from the date of original purchase.

During the warranty period the R.L. DRAKE COMPANY or an authorized Drake service facility will provide, free of charge, both parts and labor necessary to correct defects in material and workmanship. At its option, R.L. DRAKE COMPANY may replace a defective unit.

To obtain such warranty service, the original purchaser must:

- (1) Retain invoice or original proof of purchase to establish the start of the warranty period.
 - (2) Notify the R.L. DRAKE COMPANY or the nearest authorized service facility, as soon as possible after discovery of a possible defect, of:
 - (a) the model and serial number,
 - (b) the identity of the seller and the approximate date of purchase; and
 - (c) A detailed description of the problem, including details on the electrical connection to associated equipment and the list of such equipment.
 - (3) Deliver the product to the R.L. DRAKE COMPANY or the nearest authorized service facility, or ship the same in its original container or equivalent, fully insured and shipping charges prepaid.
- Correct maintenance, repair, and use are necessary to obtain proper performance from this product. Therefore carefully read the Instruction Manual. This warranty does not apply to any defect that R.L. DRAKE COMPANY determines is due to:
- (1) Improper maintenance or repair, including the installation of parts or accessories that do not conform to the quality and specifications of the original parts.
 - (2) Misuse, abuse, neglect or improper installation.
 - (3) Accidental or intentional damage.

All implied warranties, if any, including warranties of merchantability and fitness for a particular purpose, terminate three (3) years from the date of the original purchase.

The foregoing constitutes R.L. DRAKE COMPANY'S entire obligation with respect to this product, and the original purchaser shall have no other remedy and no claim for incidental or consequential damages, losses or expenses. Some states do not allow limitations on how long an implied warranty lasts or do not allow the exclusions or limitation of incidental or consequential damages, so the above limitation and exclusion may not apply to you.

This warranty gives you specific legal rights and you may also have other rights which vary from state to state. This warranty shall be construed under the laws of Ohio.

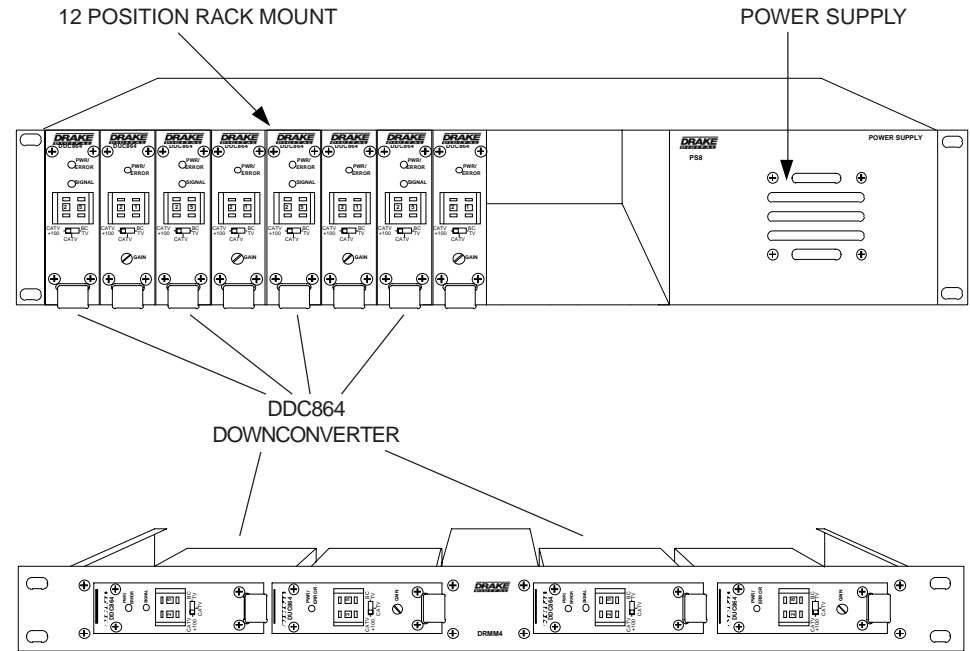

The R.L. Drake DDC864 is a low noise downconverter designed for translating digital signals from their off-air or CATV channel to a 44 MHz IF output. The output of the DDC864 can be connected to a DUC series upconverter to place the digital signal on a new output channel.

When the DDC864 is used with the DUC550 or DUC860, all input/output channel combinations are usable except "on channel" conversions.

When the DDC864 is used with the DUC864, "on channel" conversions, (the same input channel on the DCC and output channel on the DUC) are acceptable.

The DDC864 provides low noise figure and low phase noise as well as a flat passband to minimize signal deterioration.

The DDC864 is optimized for use with ATSC 8VSB modulation in a 6 MHz wide channel assignment. The passband is designed for optimized operation with 8VSB signals in an adjacent channel environment. For translation of QAM signals, the Drake model QQP860 is preferred for this task.

TM is a trademark of the R.L. Drake Company

DRAKE®
 R.L. DRAKE COMPANY
 230 INDUSTRIAL DRIVE
 FRANKLIN, OHIO 45005 U.S.A.
 CUSTOMER SERVICE AND PARTS TELEPHONE: +1 (937) 746-6990
 TELEFAX: +1 (937) 806-1576
 WORLD WIDE WEB SITE: <http://www.rldrake.com>

DRAKE® is a registered trademark of the R.L. Drake Company
 Copyright 2006 R.L. Drake Company P/N: 3852391A-1-2006 Printed in the U.S.A.

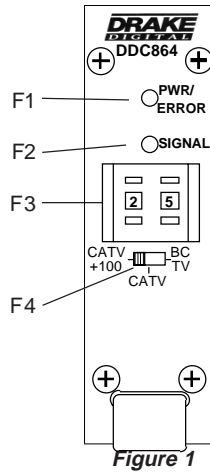

Figure 1

F1 - POWER/ERROR Indicator

Lights when the unit is connected to the required source of DC power via the rear panel DC INPUT connector. A flashing condition indicates an invalid channel setting or other conditions that would cause the unit to operate on an invalid channel. The RF output is switched off for flashing (ERROR) conditions.

F2 - SIGNAL Indicator

Lights when a signal is present.

F3 - Channel Number Switch

Sets the desired operating channel for standard CATV channels 02 through 135 or Broadcast TV channels 02 through 69. See also Item F4 which sets the type of channel (CATV or Broadcast TV) and sets the leading "1" for CATV channels 100 through 135.

F4 - Mode Switch

Sets the type of channel, CATV or Broadcast TV ("BC TV"). The "+100" position sets a leading "1" for CATV channels 100 through 135. See also Item F3 for setting the channel number.

For example:
Setting for CATV channel "124"-

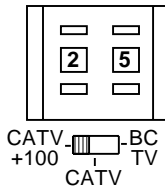

For example:
Setting for CATV channel "75"-

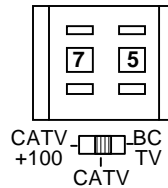

RF INPUT

Frequency Range: 54 to 864 MHz;
OFF-AIR channels 2 to 69,
CATV channels 2 to 135.
Input level Range: -30 dBmV to +30 dBmV.
Impedance: 75 Ohms, return loss of 8 dB
Noise Figure: 10 dB, typical.
Image Rejection: 55 dB.

Output

IF Frequency: 44 MHz.
Level: +30 dBmV, ±1 dB.
Impedance: 75 Ohms, return loss of 20 dB
Frequency Stability: ±5 PPM.
Channel Bandwidth: 6 MHz SAW filtered.
SSB Phase Noise: -95 dBc @ 10 kHz offset.
Amplitude Flatness
(6 MHz Channel): ±3 dB over center 5 MHz
C/N: 50 dB with +10 dBmV input level.
MER with 8VSB: >35 dB (equalized).

GENERAL

DC Power Input: +12 V ±5% @ 275 mA.
+5 V ±5% @ 275 mA.
Operating Temperature: 0°C to +50°C ambient.
Size: 1" W x 3.5" H x 9.25" D. (2.5 cm) W x (8.9 cm) H x (23.5 cm) D.
Weight: 14.5 oz. (0.41 Kg).

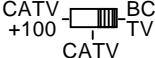
TABLE 2: BC TV 

VHF BROADCAST CHANNELS	
Channel Number	Center of Channel Frequency (MHz)
2	57
3	63
4	69
5	79
6	85
7	177
8	183
9	189
10	195
11	201
12	207
13	213



UHF BROADCAST CHANNELS	
Channel Number	Center of Channel Frequency (MHz)
14	473
15	479
16	485
17	491
18	497
19	503
20	509
21	515
22	521
23	527
24	533
25	539
26	545
27	551
28	557
29	563
30	569
31	575
32	581
33	587
34	593
35	599
36	605
37	611
38	617
39	623
40	629
41	635
42	641
43	647
44	653
45	659
46	665
47	671
48	677
49	683
50	689
51	695
52	701
53	707
54	713
55	719
56	725
57	731
58	737
59	743
60	749
61	755
62	761
63	767
64	773
65	779
66	785
67	791
68	797
69	803

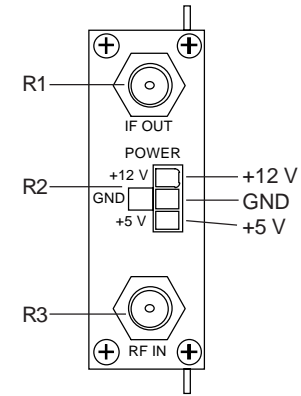

Figure 2

R1 - IF OUTPUT Connector

This is the 44 MHz IF output. The level is +30 dBmV.

R2 - DC INPUT Connector

This 3-pin connector (Male) accepts the appropriate mating DC power cable. Observe proper orientation and wiring.

R3 - RF IN Connector

This is the downconverter RF input from an antenna or CATV feed.

CONNECTIONS AND CONTROLS

All connections to and from each upconverter are made through the rear panel.

DESCRIPTION

Figure 3 shows a typical installation utilizing the Drake DRMM12 rack with 4 DDC864 downconverters, and 4 DUC upconverters. A PS8 power supply module is used to power all units.

RACK MOUNTING

Adequate ventilation is very important in multichannel installations. Units should be spaced apart vertically by at least 1.75" wherever possible, and some air movement is mandatory in enclosed rack cabinets. Excessive heat will shorten component life and performance will be degraded without proper cooling.

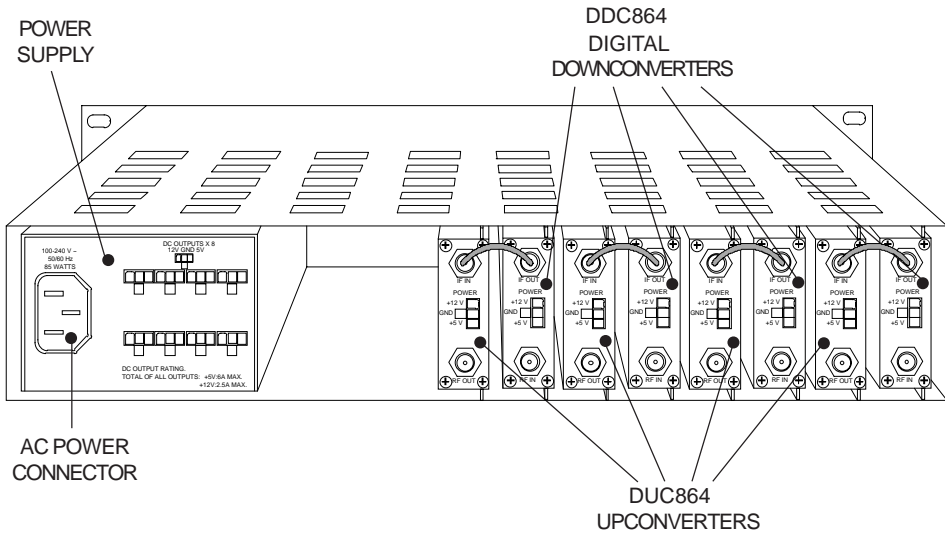

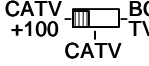

Figure 3

TABLE 1: CATV  CATV

CABLE TV CHANNELS	
Channel Number	Center of Channel
EIA/NCTA Numeric Equivalent	Frequency in MHz
2	57
3	63
4	69
5	79
6	85
95	93
96	99
97	105
98	111
99	117
14	123
15	129
16	135
17	141
18	147
19	153
20	159
21	165
22	171
7	177
8	183
9	189
10	195
11	201
12	207
13	213
23	219
24	225
25	231
26	237
27	243
28	249
29	255
30	261
31	267
32	273
33	279
34	285
35	291
36	297
37	303
38	309
39	315
40	321

CABLE TV CHANNELS	
Channel Number	Center of Channel
EIA/NCTA Numeric Equivalent	Frequency in MHz
41	327
42	333
43	339
44	345
45	351
46	357
47	363
48	369
49	375
50	381
51	387
52	393
53	399
54	405
55	411
56	417
57	423
58	429
59	435
60	441
61	447
62	453
63	459
64	465
65	471
66	477
67	483
68	489
69	495
70	501
71	507
72	513
73	519
74	525
75	531
76	537
77	543
78	549
79	555
80	561
81	567
82	573
83	579
84	585
85	591

CABLE TV CHANNELS	
Channel Number	Center of Channel
EIA/NCTA Numeric Equivalent	Frequency in MHz
86	597
87	603
88	609
89	615
90	621
91	627
92	633
93	639
94	645
	
100	651
101	657
102	663
103	669
104	675
105	681
106	687
107	693
108	699
109	705
110	711
111	717
112	723
113	729
114	735
115	741
116	747
117	753
118	759
119	765
120	771
121	777
122	783
123	789
124	795
125	801
126	807
127	813
128	819
129	825
130	831
131	837
132	843
133	849
134	855
135	861