

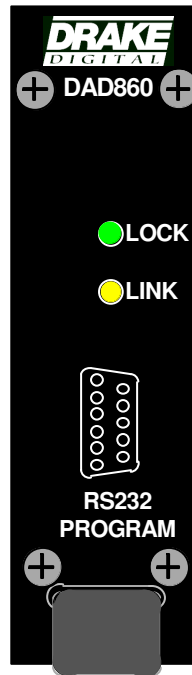



*DAD860 and DAD860A
Digital to Analog Decoders*

Instruction Manual



2 Caution Statements

WARNING: TO PREVENT FIRE OR ELECTRICAL SHOCK DO NOT EXPOSE TO RAIN OR MOISTURE

	CAUTION RISK OF ELECTRIC SHOCK DO NOT OPEN	
CAUTION: TO REDUCE THE RISK OF ELECTRIC SHOCK, DO NOT REMOVE COVER NO USER-SERVICEABLE PARTS INSIDE REFER SERVICING TO QUALIFIED PERSONNEL		



A product and cart combination should be moved with care. Quick stops, excessive force and uneven surfaces may cause the product and cart combination to overturn.

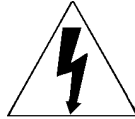

The lightning flash with arrow head symbol, within an equilateral triangle, is intended to alert the user to the presence of uninsulated "dangerous voltage" within the product's enclosure that may be of sufficient magnitude to constitute a risk of electric shock to persons.



The exclamation point within an equilateral triangle is intended to alert the user to the presence of important operating and maintenance (servicing) instructions in the literature accompanying the product.

WARNING: TO REDUCE THE RISK OF FIRE OR ELECTRIC SHOCK, DO NOT EXPOSE THIS PRODUCT TO RAIN OR MOISTURE.
DO NOT OPEN THE CABINET, REFER SERVICING TO QUALIFIED PERSONNEL ONLY.

CAUTION: TO PREVENT ELECTRIC SHOCK, DO NOT USE THIS (POLARIZED) PLUG WITH AN EXTENSION CORD RECEPTACLE OR OTHER OUTLET UNLESS THE BLADES CAN BE FULLY INSERTED TO PREVENT BLADE EXPOSURE.

ATTENTION: POUR PREVENIR LES CHOCS ELECTRIQUES, NE PAS UTILISER CETTE FICHE POLARISEE AVEC UN PROLONGATEUR, UNE PRISE DE COURANT OU UNE AUTRE SORTIE DE COURANT, SAUF SI LES LAMES PEUVENT ETRE INSEREES A FOND SANS EN LAISSER AUCUNE PARTIE A DECOUVERT.

- 1. Read Instructions**—All the safety and operating instructions should be read before the product is operated.
- 2. Retain Instructions**—The safety and operating instructions should be retained for future reference.
- 3. Heed Warnings**—All warnings on the product and in the operating instructions should be adhered to.
- 4. Follow Instructions**—All operating and use instructions should be followed.
- 5. Cleaning**—Unplug this product from the wall outlet before cleaning. Do not use liquid cleaners or aerosol cleansers. Use a damp cloth for cleaning.
- 6. Attachments**—Do not use attachments that are not recommended by the product manufacturer as they may cause hazards.
- 7. Water and Moisture**—Do not use this product near water—for example, near a bathtub, wash bowl, kitchen sink or laundry tub; in a wet basement; or near a swimming pool; and the like.
- 8. Accessories**—Do not place this product on an unstable cart, stand, tripod, bracket, or table. The product may fall, causing serious injury to a child or adult, and serious damage to the product. Use only with a cart, stand, tripod, bracket, or table recommended by the manufacturer, or sold with the product. Any mounting of the product should follow the manufacturer's instructions, and should use a mounting accessory recommended by the manufacturer.
- 9. A product and cart combination should be moved with care.** Quick stops, excessive force, and uneven surfaces may cause the product and cart combination to overturn.
- 10. Ventilation**—Slots and openings in the cabinet are provided for ventilation and to ensure reliable operation of the product and to protect it from overheating, and these openings must not be blocked or covered. The openings should never be blocked by placing the product on a bed, sofa, rug, or similar surface. This product should not be placed in a built-in installation such as bookcase or rack unless proper ventilation is provided or the manufacturer's instructions have been adhered to.
- 11. Power Sources**—This product should be operated only from the type of power source indicated on the marking label. If you are not sure of the type of power supplied to your home, consult your product dealer or local power company. For products intended to operate from battery power, or other sources, refer to the operating instructions.
- 12. Grounding or Polarization**—This product may be equipped with a polarized alternating-current line plug (a plug having one blade wider than the other). This plug will fit into the power outlet only one way. This is a safety feature. If you are unable to insert the plug fully into the outlet, try reversing the plug. If the plug should still fail to fit, contact your electrician to replace your obsolete outlet. Do not defeat the safety purpose of the polarized plug.
Alternate Warnings—If this product is equipped with a three-wire grounding-type plug, a plug having a third (grounding) pin, the plug will only fit into a grounding-type power outlet. This is a safety feature. If you are unable to insert the plug into the outlet, contact your electrician to replace your obsolete outlet. Do not defeat the safety purpose of the grounding-type plug.
- 12 a. Mise à la terre ou Polarisation**—Cet appareil est équipé avec un cordon d'alimentation à trois fils. Il est à brancher sur une prise ayant un connecteur à la terre. Assurez-vous que la connection à la terre ne manque pas.
- 13. Power-Cord Protection**—Power-supply cords should be routed so that they are not likely to be walked on or pinched by items placed upon or against them, paying particular attention to cords at plugs, convenience receptacles, and the point where they exit from the product.

- 14. Outdoor Antenna Grounding**—If an outside antenna or cable system is connected to the product, be sure the antenna or cable system is grounded so as to provide some protection against voltage surges and built-up static charges. Article 810 of the National Electrical Code, ANSI/NFPA 70, provides information with regard to proper grounding of the mast and supporting structure, grounding of the lead-in wire to an antenna discharge unit, size of grounding conductors, location of antenna-discharge unit, connection to grounding electrodes, and requirements for the grounding electrode. See Figure A.
- 15. Lightning**—For added protection for this product during a lightning storm, or when it is left unattended and unused for long periods of time, unplug it from the wall outlet and disconnect the antenna or cable system. This will prevent damage to the product due to lightning and power-line surges.
- 16. Power Lines**—An outside antenna system should not be located in the vicinity of overhead power lines, other electric light or power circuits, where it can fall into such power lines or circuits. When installing an outside antenna system, extreme care should be taken to keep from touching such power lines or circuits as contact with them may be fatal.
- 17. Overloading**—Do not overload wall outlets, extension cords, or integral convenience receptacles as this can result in a risk of fire or electric shock.
- 18. Object and Liquid Entry**—Never push objects of any kind into this product through openings as they may touch dangerous voltage points or short-out parts that could result in a fire or electric shock. Never spill liquid of any kind on the product.
- 19. Servicing**—Do not attempt to service this product yourself as opening or removing covers may expose you to dangerous voltage or other hazards. Refer all servicing to qualified service personnel.
- 20. Damage Requiring Service**—Unplug this product from the wall outlet and refer servicing to qualified service personnel under the following conditions:
 - a. When the power-supply cord or plug is damaged,
 - b. If liquid has been spilled, or objects have fallen into the product,
 - c. If the product has been exposed to rain or water,
 - d. If the product does not operate normally by following the operating instructions. Adjust only those controls that are covered by the operating instructions as an improper adjustment of other controls may result in damage and will often require extensive work by a qualified technician to restore the product to its normal operation,
 - e. If the product has been dropped or damaged in any way, and
 - f. When the product exhibits a distinct change in performance—this indicates a need for service.
- 21. Replacement Parts**—When replacement parts are required, be sure the service technician has used replacement parts specified by the manufacturer or have the same characteristics as the original part. Unauthorized substitutes may result in fire, electric shock or other hazards.
- 22. Safety Check**—Upon completion of any service or repairs to this product, ask the service technician to perform safety checks to determine that the product is in proper operating condition.
- 23. Wall or Ceiling Mounting**—The product should be mounted to a wall or ceiling only as recommended by the manufacturer.
- 24. Heat**—The product should be situated away from heat sources such as radiators, heat registers, stoves, or other products (including amplifiers) that produce heat.

NOTE TO CATV SYSTEM INSTALLERS:
THIS REMINDER IS PROVIDED TO CALL THE CATV SYSTEM INSTALLER'S ATTENTION TO ARTICLE 820 - 40 OF THE NEC THAT PROVIDES GUIDELINES FOR PROPER GROUNDING AND, IN PARTICULAR, SPECIFIES THAT THE CABLE GROUND SHALL BE CONNECTED TO THE GROUNDING SYSTEM OF THE BUILDING, AS CLOSE TO THE POINT OF CABLE ENTRY AS PRACTICAL.

Figure A
Example of antenna grounding as per National Electrical Code, ANSI/NFPA 70

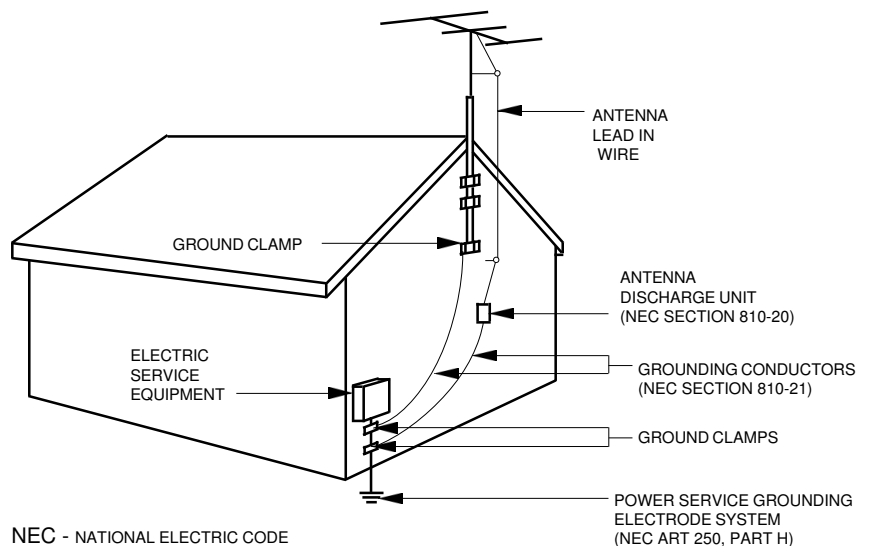

NEC - NATIONAL ELECTRIC CODE

4 Table of Contents / Specifications

TABLE OF CONTENTS

- 2 Caution Statements
- 3 Important Safety Instructions
- 4 Table of Contents / Specifications
- 5 General Description / Installation and Mounting
- 6 DAD860 and DAD860A Connections / Notes
- 7 DAD860 Controller Controls and Connections
- 8 DAD860 Setup and Programming
- 11 CATV Channel Frequencies
- 12 Broadcast TV Channel Frequencies
- 13 Service / If You Need To Call For Help
- 14 Warranty

DAD860 & DAD860A SPECIFICATIONS

RF INPUT

Frequency Range: 54 MHz to 864 MHz
Channel Plans: Broadcast, STD CATV, HRC, IRC
Input Channel BW: 6 MHz
Demod Modes:
Broadcast: 8VSB, ATSC Standard-
18 video formats
CATV: 64QAM, 256QAM Annex B
Auto Detected
Symbol Rates:
8VSB: 10.76 MS/s
64QAM: 5.057 MS/s
256QAM: 5.3606 MS/s
Recommended
Input Level Range:
8VSB: -26 to +30 dBmV
64 QAM: -15 to +15 dBmV
256QAM -12 to +15 dBmV
Input Connector: Type F Female,
Impedance: 75 Ohms
Return Loss: 6 dB or better

ASI OUTPUT (DAD860A only)

Connector Front Panel BNC
TS Stream Type MPTS or SPTS
Included Program(s) All programs that are present in the
demodulated RF channel.
Clock DVB-ASI stream w.270 MHz clock.

NTSC VIDEO AND AUDIO OUTPUTS

Video Output Connector: Type F, Female
Impedance: 75 Ohms
Level: 1 V p-p.
Format: 480i NTSC
VBI Data: NTSC Parental Control and EIA-608
Closed Captioning
Audio Outputs: L & R, Mono or Stereo
Level: 250 mV rms nominal, user adjustable
Aspect Ratio: AFD Ready.
User Programmable -
Cropped, Ltr Box, Stretched, AFD/Ltr
Box, AFD/Cropped

GENERAL

Power Requirement:
DAD860 5 VDC, 390 mA
12VDC, 220 mA
DAD860A 5 VDC, 550 mA
12 VDC @ 260 mA
Supplied by Drake PSM121 or RMM4

Dimensions and Weight:

DAD860 3.43" H x 1.024" W x 9.5" D
13.1 oz.
DAD860A 3.43" H x 1.024"W x 12.5" D
14.5 oz.

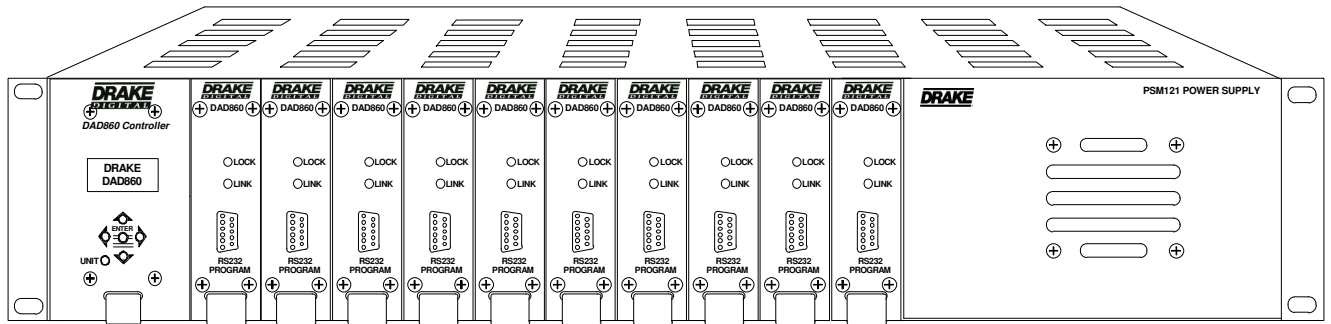

GENERAL DESCRIPTION

The R. L. Drake DAD860 and DAD860A are high quality, low noise, frequency agile, digital to analog decoders designed for receiving digital signals from off-air or CATV channels. Output of the DAD860 is baseband NTSC video and stereo audio. The DAD860A, only, has these NTSC outputs plus an additional ASI output containing the entire demodulated transport stream for the tuned RF channel (all programs included).

The NTSC output of a DAD860 or DAD860A can be connected to VMM series modulators to place the programming on an off-air or CATV channel, or to any other device requiring baseband audio and video input.

Parameters for the DAD860 can be set up with the DAD860 Controller Module or by front panel RS232 connection to a PC running 'DAD860 Remote Control Software'.

The one-unit wide module can be rack mounted using the 12 position RMM12 rack mount, and is powered by the Drake PSM121 Power Supply. Up to 10 units plus the DAD860 Controller Module, or 12 units without the Controller Module can be mounted in the 12 position rack mount. If no controller is required, the RMM4 chassis and power supply may be used for up to 4 DAD860s. DAD860As require more current from the power supply and thus require the above capacity to be reduced by two.

INSTALLATION AND MOUNTING

Install the decoders in the RMM12 rack mounting frame. Slide each module into the frame from the front so that the mounting rails on the top and bottom of the DAD engage the mounting tracks on the frame. Similarly, mount the PSM121 Power Supply, again making sure that its mounting rails line up with the tracks in the frame. Apply the same mounting procedure to the DAD860 Controller.

Note that, while the drawings on this page show only DAD860s installed, various combinations of DAD860(A)s and VMM600 or VMM860 modulators could be installed in the same RMM12 or RMM4.

Plug the supplied power cable into the receptacle on the rear of the PSM121 Power Supply, and attach a connector to the POWER receptacle on the rear of each of the DAD860s, VMM modulators, and the DAD860 Controller if used.

If the DAD860 Controller is used, plug the supplied cable into the COMM receptacle on its rear panel. You will note that the other end of this cable terminates in ten three conductor female connectors. Insert one of these connectors into the LINK receptacle on each of the DAD860s installed in the rack. While these connectors can be inserted in any order, it is suggested that cables be connected to the DAD860s in numerical order from either left to right or right to left - depending on which side of the rack the DAD Controller is mounted.

Connect an RF source (off-air or CATV) to the RF IN connector on each unit and connect the VIDEO OUT and AUDIO L and R connections to the appropriate inputs of each modulator or other desired device.

Then connect the power supply power connector to the appropriate power source using the supplied line cord.

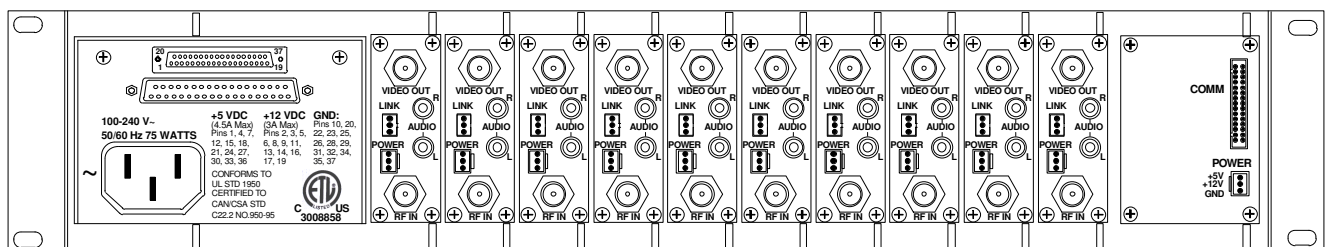

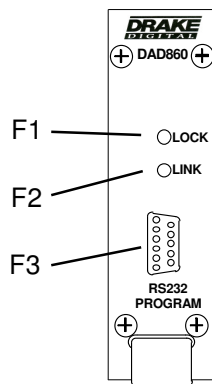

FRONT PANEL INDICATORS & CONNECTIONS

F1 - LOCK LED - This green LED lights continuously when the DAD860 is locked to the selected incoming signal. If the lock is lost, such as when no signal or a noisy signal is present, this LED will flash on and off continuously

F2 - LINK LED - This amber LED flashes on and off when the particular DAD860 is selected for programming by the DAD860 CONTROLLER or 'DAD860 REMOTE CONTROL SOFTWARE'.

F3 - RS232 PROGRAM - This RS232 connector is intended to attach to a PC running 'DAD860 REMOTE CONTROL SOFTWARE' for programming the DAD860 as an alternative to using the DAD860 CONTROLLER module.

F4 - ASI OUTPUT, BNC CONNECTOR - not shown. This BNC connector is only provided on the DAD860A model and is located just above the LOCK LED.

RMM12 INSTALLATION OF DAD860 AND DAD860A

The DAD860A draws additional current from the power supply compared to the DAD860 model. Thus when the DAD860A is paired with VMM series agile modulators, one less DAD860A/VMM pair can be used compared to use with the VMM600 or VMM860 fixed modulators. Example useable combinations are:

10 DAD860A + 1 PSM121 + 2 open spaces
 6 DAD860A + 6 VMM600 + 1 PSM121
 5 DAD860A + 5 VMM860AG/AS + 1 PSM121

12 DAD860 + 1 PSM121
 6 DAD860 + 6 VMM (fixed or agile) + 1 PSM121

Other combinations are possible. The user must refer to the specification for each model and make sure that total load will not exceed the PSM121 rating.

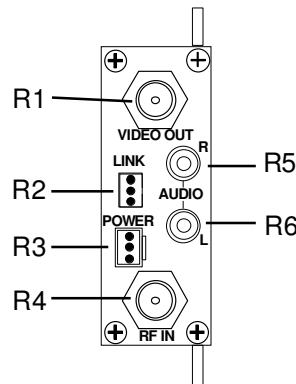

REAR PANEL CONNECTIONS

R1 - VIDEO OUT - This "F" type connector supplies the NTSC baseband video output to a modulator or other suitable device.

R2 - LINK - This receptacle connects to one of the ten serial cables from the DAD860 CONTROLLER module for programming the desired parameters into the DAD860.

R3 - POWER - This receptacle connects to one of the twelve power cables from the PSM121 power supply. The cable provides +5V, +12V and GND to each device to which it is connected.

R4 - RF IN - This "F" type connector attaches to a CATV (QAM) or off-air (8-VSB) digital TV signal source.

R5 & R6 - AUDIO L & R - These two RCA Phono connectors provide left and right stereo audio output to a modulator or other suitable device.

DAD860 CONTROL MODULE

The DAD860 Control Module may be used to control either the DAD860 or DAD860A. Models may be mixed and use a single controller.

The DAD860 Control Module is 2 units wide and thus, if used, one pair of DAD/VMM must be replaced by the controller. For example: one could control 10 DAD860 units but only 8 DAD860A units in one RMM12.

RMM4 INSTALLATION OF DAD860 AND DAD860A

Any combination of DAD860, DAD860A, and VMM series - either fixed or agile - can be mounted 'on their side' in the RMM4 rack.

FRONT PANEL INDICATORS & CONNECTIONS

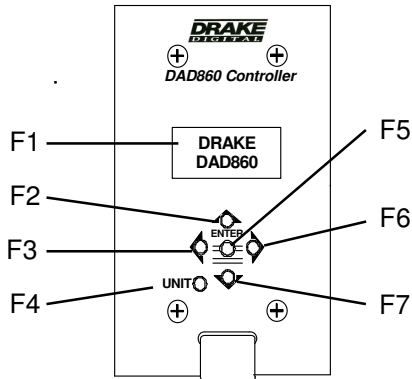

F1 - LCD DISPLAY - This displays the selected DAD860 unit number, the selected parameter, and its value.

F2 - UP Button - When in program mode, this button scrolls upward through the available parameter values. When not in the program mode, this button will have no effect.

F3 - LEFT Button - This button scrolls counterclockwise through the available parameters for the selected unit.

F4 - UNIT Button - This button scrolls in numeric order through the available DAD860 units. When a unit is selected, its amber LINK LED will flash continuously. While the LINK light is flashing, the LCD will display the selected unit number and the signal to noise ratio of the received signal or "NO LOCK" if no signal is being received. After a unit is selected, the controller backlight and the selected unit's amber LINK light will extinguish after approximately 40 seconds if there are no other control inputs.

F5 - ENTER Button - Pressing this button for two seconds will enter the program mode for the selected DAD860. This is indicated by the LCD flashing on and off at an interval of approximately one second. Once in the program mode, pressing ENTER will store the value of the selected parameter and exit program mode.

F6 - RIGHT Button - When in program mode, pressing this button will save the selected parameter value and will then scroll clockwise to the next parameter, while remaining in the program mode. When not in program mode, it will scroll clockwise through available parameters without saving any data. When in program mode, it is also used to access secondary menus, progress through secondary menu trees and to store the value selections in these menus.

F7 - DOWN Button - When in program mode, this button scrolls downward through the available parameters. When not in the program mode, it will have no effect.

6

REAR PANEL INDICATORS & CONNECTIONS

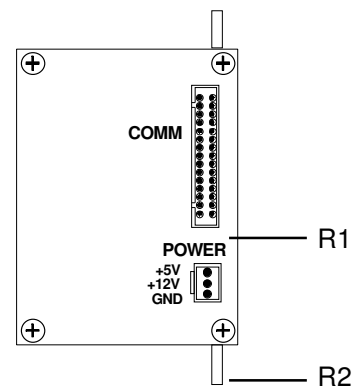

R1 - COMM Connector - This connector provides a means of connecting the controller to each of the DAD860 units. A supplied cable is attached to this connector the other end of which is terminated in ten numbered three conductor connectors. The connector number corresponds to the unit number of the DAD860 to which it is connected.

R2 - POWER Connector - This three conductor connector connects to one of the twelve cables from the PSM121 power supply to supply power for the programmer.

POWER SUPPLY

The DAD860 requires multiple power supply voltages that are all obtained from the Drake model PSM121 power supply module. The PSM121 mounts in the RMM12 rack tray along with one to twelve DAD860 decoders (or other similar Drake models such as VMM600 series modulators). The PSM121 provides +5V, +12V and GND connections to each unit.

The PSM121 operates over a wide range of AC input voltages from 90 VAC to 240 VAC, 50/60 Hz, and has an 3 wire line cord receptacle. Power consumption from the AC line will be around 60 W with twelve DAD860 decoders installed. In many cases, the power will be below this level.

8 DAD860 Setup and Programming

INTRODUCTION

The programming of each DAD860(A) in an RMM12 rack mounting frame is done with the DAD860 Controller, or by a PC running Drake 'DAD860 Remote Control Software'. The following discussion will describe the use of the DAD860 Controller. Use of 'DAD860 Remote Control Software' will be covered in documentation included with the software.

NOTE: The information presented on pages 8, 9, and 10 applies to the DAD860 and DAD860A even though the references will only mention DAD860.

The UNIT button on the DAD860 Controller is used to select the unit to be programmed. The actual programming is done via the UP, DOWN, LEFT, RIGHT and ENTER buttons.

The chart below shows each of the menus that are available for parameter value setup and/or viewing for the DAD860 being programmed. Pressing the LEFT or RIGHT arrow buttons will navigate through these menus. You may do this without danger of disturbing any of the current settings when not in program mode.

As you navigate through the menus the parameter name is listed on the top line of the display and the current value is shown on the bottom line. For setup purposes, it is best to progress clockwise through the chart (use the right arrow button), starting from the default UNIT # screen.

In the chart below shows the values that are available in each of these menus. **DAD860 CONTROLLER MENU FLOW CHART**

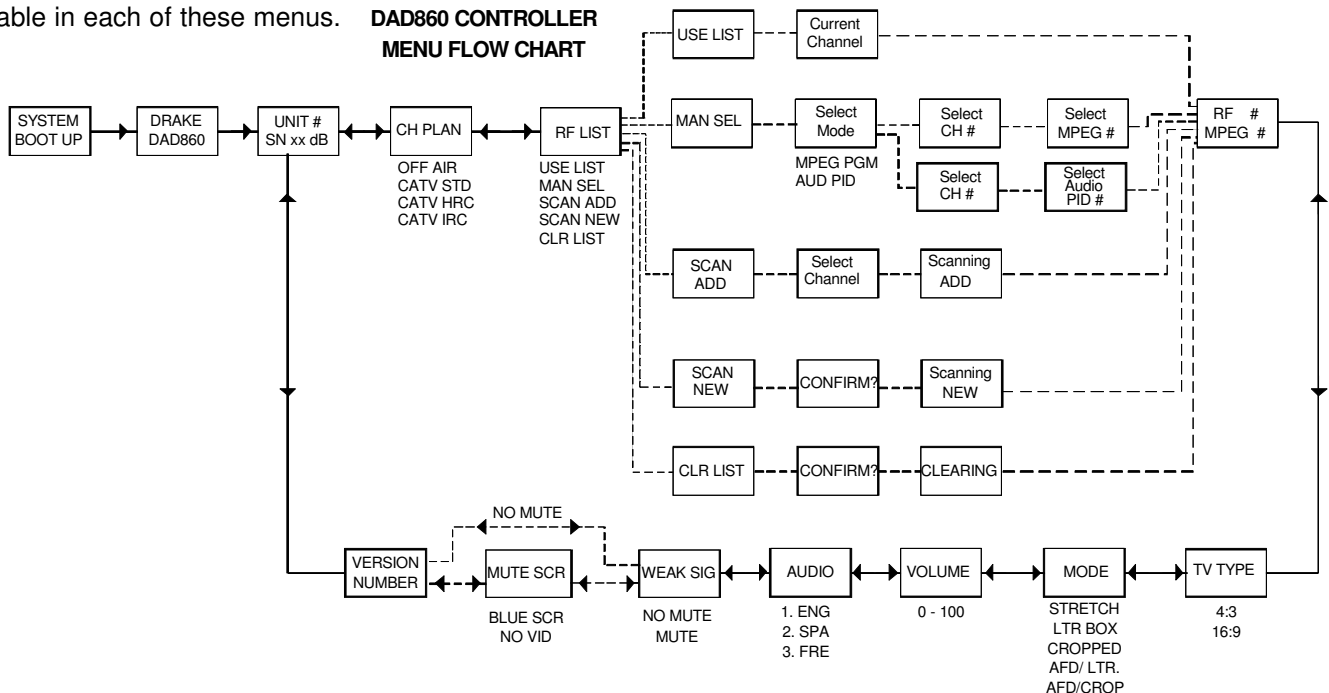

PROGRAMMING

To adjust and set a parameter value, enter the program mode by pressing the center ENTER button for approximately 3 seconds until the display begins to flash. You are now in the program mode and the UP and DOWN buttons will take you through the various values for a given parameter.

Find the desired value for the selected parameter and use the RIGHT arrow button to save that value and progress to the next parameter, while remaining in the program mode. (If the ENTER key is used, the parameter value will be saved and program mode exited.)

Proceed in this manner until all parameters have been set to the desired value. Then press the ENTER button to exit program mode and use the UNIT key to proceed to the next DAD860 to be programmed.

Pressing the LEFT arrow button while in program mode will back up to the previous parameter without saving the current parameter value to memory.

Once programming for a given DAD860 has been completed, the information will be retained in the units memory until it is reprogrammed, even when power is removed.

RF LIST SECONDARY MENUS

A DAD860 can store in its memory a **list** of all of the digital channels and the MPEG programs they contain, which it can receive from the CATV or off-air signal source to which it is connected. The values shown for the RF LIST parameter each lead to secondary menus that allow manipulation of this stored channel and MPEG information. The following is a description of each of these secondary menu functions. These secondary menus can only be accessed when in the program mode.

USE LIST - This function allows selection of the desired channel and MPEG program from a channels LIST previously stored the DAD860's memory. From the "RF LIST" parameter screen USE LIST is the default value.

1. Press the RIGHT arrow button. "USE LIST" and the currently stored channel number will be displayed.
2. Press the RIGHT button again. This will take the operator to "RF # - MPEG #" screen where the desired channel and MPEG numbers can be selected from the stored list using the UP and DOWN arrow buttons.
3. Press the RIGHT arrow button again to save the value and proceed to the next parameter in the primary menu.

MAN SEL - This function allows storage of a particular RF channel and MPEG program value whether or not signals are being received. It is also used to select a specific audio PID if that is desired.

1. From the "RF LIST" screen, use the UP or DOWN arrow buttons to select MAN SEL.
2. In the MAN SELECT menu, choose MPEG PGM to select a specific MPEG program OR choose AUD PID to select one specific audio PID on this RF channel. Video from the program containing this audio PID will play, if available. Enter PID in decimal format.
3. Press the RIGHT arrow button. A MPEG PGM or AUD PID RF CH# screen will appear.
4. Use the UP and DOWN arrow buttons to select the desired RF channel.
5. Press the RIGHT arrow button again. If MPEG PGM was chosen in step 2, the "MPEG PGM" screen will appear. Use the UP and DOWN arrow buttons to select the desired MPEG program number. If AUD PID was chosen, a screen will appear to allow setting any audio PID number, do so now.
6. Press the RIGHT arrow button again. This will take you to the "RF # - MPEG #" screen in the main menu with the desired channel selected.
7. Press the RIGHT arrow button again to save the value and proceed to the next parameter in the primary menu.

SCAN ADD - This function allows storage of an additional channel to either a previously stored list or an empty list, when the DAD860 is connected to a signal source.

1. From the "RF LIST" screen, use the UP and DOWN arrow buttons to select SCAN ADD.
2. Press the RIGHT arrow button. The "SCAN ADD - CH 002" screen will appear.
3. Use the UP and DOWN arrows to select the desired channel.
4. Press the RIGHT arrow button again. The "SCAN ADD >>>>" screen will appear followed momentarily by the SCAN LOCK screen and on to the "RF # MPEG" screen. At this point the unit will exit program mode.
6. At this point you can re-enter program mode, proceed to the "RF # - MPEG #" screen and select the desired MPEG number for the newly added channel.
7. Press ENTER to exit program mode.

NEW SCAN - This function is used to populate an empty list when the unit is attached to a signal source.

1. From the "RF LIST" screen use the UP or DOWN arrows to select NEW LIST.
2. Press the RIGHT arrow button. The "SCAN NEW" screen will appear.
3. Press the RIGHT arrow button again. A "CONFIRM?" screen will appear.
4. An additional press of the RIGHT arrow button will produce a "SCAN NEW - >>>>>>>>" screen which will remain while the unit scans all channels. This could take a minute or two.
5. When scanning is complete, you will briefly see a "LOCK" screen followed by the "RF # - MPEG #" screen in the main menu. You can then select the desired channel from the newly stored list and proceed to the next parameter in the primary menu.

CLR LST - This function is used to erase all information from the units memory in preparation for reprogramming.

1. From the "RF LIST" screen, use the UP or DOWN arrows to select CLR LIST.
2. Press the RIGHT arrow button. This will produce a "CLR LIST" screen.
3. Press the RIGHT arrow button again. A "CONFIRM?" screen will appear.
4. An additional depression of the RIGHT arrow will produce a "CLEARING - >>>>>>>>" screen followed shortly by the "RF # - MPEG #" screen which will now say "EMPTY"
5. You can now press the LEFT arrow button to return to the "RF LIST" screen where you can select the method you wish to use to reprogram the unit's memory.

10 DAD860 Setup and Programming (cont.)

ADDITIONAL MENU ITEMS

RF # - MPEG # - This menu screen allows selection of the desired channel and MPEG program from the list saved in memory or by one of the methods in the secondary menus described previously.

TV TYPE - Since the purpose of the DAD860 is usually to provide 480i, 4:3 aspect ratio video for display as a 480i signal, choose the 4:3 setting.

MODE - This selection determines how the video will be displayed on the TV screen. One of the AFD modes is recommended. **"AFD/LTR"** and **"AFD/CROP"** use data that may be transmitted by the broadcaster via the AFD (Active Format Description) codes to automatically switch the DAD860's output between cropped or letterbox display to provide the optimum viewing experience on a 4:3 TV. If no codes are being transmitted, the aspect ratio will default to **"LTR BOX"** or **"CROPPED"** respectively. If it is desirable to ignore AFD codes and force a particular mode, that may be done by selecting one of the following settings. When wide screen video is being received, **"CROPPED"** truncates the left and right sides of the picture and expands it vertically to fill the 4:3 sized screen. Proper geometry is maintained. This mode is sometimes called "Center Cut". **"LTR BOX"** will show the entire picture without distortion, but will leave black bars above and below the picture. **"STRETCH"** expands the picture vertically without cropping the left and right sides. The **"STRETCH"** mode is seldom used.

VOLUME - This menu determines the audio output level of the audio outputs. The selections are from 0 to 100. Adjust for maximum audio level without distortion. 85 is the default value.

AUDIO - Determines the language of the output audio when multiple languages are available. The choices are **"1. ENG"** (English), **"2. SPA"** (Spanish) and **"3. FRE"** (French).

WEAK SIG - This is used to select the video output that is to be displayed if the signal on the selected channel is either absent or too weak for successful decoding. The choices are **"NO MUTE"**, and **"MUTE"**. If **"NO MUTE"** is selected, pressing the RIGHT button will take the user directly to the **VERSION NUMBER** screen. However if **"MUTE"** is selected, the **MUTE SCR** screen appears with the choices of **"BLUE SCR"** (blue screen) and **"NO VID"** (no video). Use the up or down buttons to make the desired selection and press the right button to proceed to the Version Number screen. Muting, if selected, will occur if the SNR drops to 15 dB, and the unit will unmute when the SNR then reaches 17 dB or higher. With no muting selected, the screen will still go to blue screen at around 3 dB below usable 8VSB SNR.

UNIT # - SN - This is the default screen when a DAD860 is selected. It displays the unit number of the selected DAD860 as well as the signal to noise ratio (SN) of the signal being received. If no signal is being received. "NO LOCK" will be displayed instead of a signal to noise ratio.

CH PLAN - This menu allows the selection of the type of channel plan that will be received. The choices are "OFF AIR", "CATV STD", "CATV HRC" and "CATV IRC". Tables showing channel number vs frequency of CATV STD and OFF AIR (broadcast TV) channel plans are shown on pages 11 and 12 respectively.

PROGRAMMING WITH A PC

In addition to being programmed with the 'DAD860 Controller', the DAD860 can be programmed with a PC running 'DAD860 Remote Control Software'. Connection to the PC is accomplished using a standard RS232 serial cable connected from a serial port on the PC to the RS232 serial port in the front panel of the DAD860.

Details of the programming procedure are included in the documentation supplied with the software.

Once programming is complete, the RS232 cable may be removed from the DAD860. It is not necessary to leave the PC connected after programming is complete.

MEMORY RETENTION

Regardless of whether a DAD860 is programmed using the 'DAD860 Controller' or a PC running 'DAD860 Remote Control Software', a DAD860 will retain the programming even if power is removed for prolonged periods.

VERSION NUMBER - The firmware version number of the selected DAD860 is displayed on this screen.

ADD'L INFO - MANUAL SELECT PROGRAMMING

- 1) The RF channel must always be entered .
- 2) Enter the MPEG program number or an actual audio PID number, but not both. When entering an audio PID number, make sure the MPEG program number is not programmed.

TABLE 1: CATV

CABLE TV CHANNELS	
Channel Number	Center of Channel
EIA/NCTA Numeric Equivalent	Frequency in MHz
2	57
3	63
4	69
5	79
6	85
95	93
96	99
97	105
98	111
99	117
14	123
15	129
16	135
17	141
18	147
19	153
20	159
21	165
22	171
7	177
8	183
9	189
10	195
11	201
12	207
13	213
23	219
24	225
25	231
26	237
27	243
28	249
29	255
30	261
31	267
32	273
33	279
34	285
35	291
36	297
37	303
38	309
39	315
40	321

CABLE TV CHANNELS	
Channel Number	Center of Channel
EIA/NCTA Numeric Equivalent	Frequency in MHz
41	327
42	333
43	339
44	345
45	351
46	357
47	363
48	369
49	375
50	381
51	387
52	393
53	399
54	405
55	411
56	417
57	423
58	429
59	435
60	441
61	447
62	453
63	459
64	465
65	471
66	477
67	483
68	489
69	495
70	501
71	507
72	513
73	519
74	525
75	531
76	537
77	543
78	549
79	555
80	561
81	567
82	573
83	579
84	585
85	591

CABLE TV CHANNELS	
Channel Number	Center of Channel
EIA/NCTA Numeric Equivalent	Frequency in MHz
86	597
87	603
88	609
89	615
90	621
91	627
92	633
93	639
94	645
100	651
101	657
102	663
103	669
104	675
105	681
106	687
107	693
108	699
109	705
110	711
111	717
112	723
113	729
114	735
115	741
116	747
117	753
118	759
119	765
120	771
121	777
122	783
123	789
124	795
125	801
126	807
127	813
128	819
129	825
130	831
131	837
132	843
133	849
134	855
135	861

TABLE 2: BC TV

VHF BROADCAST CHANNELS	
Channel Number	Center of Channel Frequency (MHz)
2	57
3	63
4	69
5	79
6	85
7	177
8	183
9	189
10	195
11	201
12	207
13	213

UHF BROADCAST CHANNELS	
Channel Number	Center of Channel Frequency (MHz)
14	473
15	479
16	485
17	491
18	497
19	503
20	509
21	515
22	521
23	527
24	533
25	539
26	545
27	551
28	557
29	563
30	569
31	575
32	581
33	587
34	593
35	599
36	605
37	611
38	617
39	623
40	629
41	635
42	641
43	647
44	653
45	659
46	665
47	671
48	677
49	683
50	689
51	695
52	701
53	707
54	713
55	719
56	725
57	731
58	737
59	743
60	749
61	755
62	761
63	767
64	773
65	779
66	785
67	791
68	797
69	803

SERVICE INFORMATION

You may contact the R.L. DRAKE Service Department for additional information or assistance by calling +1 (937) 746-6990, Monday through Friday, between 8:00 A.M. and 4:00 P.M. Eastern Time, except on holidays.

You may also contact the R.L. DRAKE Service Department by E-mail at the following address:
TechSupport@rldrake.com
or by Telefax:
+1 (937) 806-1576.

Should you want to return your unit for service, package the unit carefully using the original carton or other suitable container.

Write your return address clearly on the shipping carton and on an enclosed cover letter describing the service required, symptoms or problems. Also include your daytime telephone number and a copy of your proof of purchase.

The unit will be serviced under the terms of the R.L. DRAKE LLC Limited Warranty and returned to you.

IF YOU NEED TO CALL FOR HELP

Call our Customer Service/Technical Support line at +1 (937) 746-6990 between 8:00 A.M. and 4:00 P.M. Eastern Time, weekdays. Please have the unit's serial number available. We will also need to know the specifics of any other equipment connected to the unit. When calling, please have the unit up and running, near the phone if possible. Our technician(s) will likely ask certain questions to aid in diagnosis of the problem. Also, have a voltmeter handy, if possible.

R.L. DRAKE also provides technical assistance by e-mail: TechSupport@rldrake.com
or by Telefax: +1 (937) 806-1576.

Many of the products that are sent to us for repair are in perfect working order when we receive them. For these units, there is a standard checkout fee that you will be charged. Please perform whatever steps are applicable from the installation sections of the Owner's Manual before calling or writing—this could save unnecessary phone charges. Please do not return the unit without contacting R.L. DRAKE first: it is preferred to help troubleshoot the problem over the phone (or by mail) first, saving you both time and money.

Inside the carton, enclose a note with your name, address, daytime phone number, and a description of the unit's problem.

The unit must be sent to the following address:

**Service Department
R.L. DRAKE LLC
230 Industrial Drive
Franklin, Ohio 45005 U.S.A.**

Be sure to include your street address which will be needed for UPS return. UPS Surface (Brown Label) takes 7-10 days to reach us depending on your location, Blue takes 2-3 days.

Red is an overnight service. Send the unit in a way that it can be traced if we can't verify receipt of shipment. We suggest UPS or insured postal shipment.

If the unit is still under the original owner's warranty, R.L. DRAKE will pay the cost of the return shipment to you. Our return shipping policy is that we will return it UPS Brown if received Brown or by US Mail, it will be returned Blue if received Blue or Red—or it will be returned however you prefer if you furnish the return cost for the method you select.

If the unit is out of warranty, use one of the following methods for return shipment:

- 1) You designate billing to American ExPress, VISA, MasterCard or Discover card;
- 2) You prepay the service charges with a personal check, or
- 3) You specify some other method of return and payment.

When calling, the technician can estimate the repair charges for you over the phone. This is another good reason to call before sending a unit in for repair. Typically, equipment is repaired in five to ten working days after it arrives at R.L. DRAKE if we have all the facts. If we must call you, it may take longer. R.L. DRAKE is not responsible for damage caused by lightning, nonprofessional alterations, "acts of God", shipping damage, poor storage/handling, etc. R.L. DRAKE will make note of any shipping damage upon receipt.

You will need to send proof of purchase to receive warranty service. Typically, a copy of the invoice from an R.L. DRAKE dealer will suffice. The warranty is for the original owner only and is not transferable.

Three Year Limited Warranty

R.L. DRAKE LLC warrants to the original purchaser this product shall be free from defects in material or workmanship for three (3) years from the date of original purchase.

During the warranty period the R.L. DRAKE LLC or an authorized Drake service facility will provide, free of charge, both parts and labor necessary to correct defects in material and workmanship. At its option, R.L. DRAKE COMPANY may replace a defective unit.

To obtain such a warranty service, the original purchaser must:

- (1) Retain invoice or original proof of purchase to establish the start of the warranty period.
- (2) Notify the R.L. DRAKE LLC or the nearest authorized service facility, as soon as possible after discovery of a possible defect, of:
 - (a) the model and serial number,
 - (b) the identity of the seller and the approximate date of purchase; and
 - (c) A detailed description of the problem, including details on the electrical connection to associated equipment and the list of such equipment.
- (3) Deliver the product to the R.L. DRAKE LLC or the nearest authorized service facility, or ship the same in its original container or equivalent, fully insured and shipping charges prepaid.

Correct maintenance, repair, and use are important to obtain proper performance from this product. Therefore carefully read the Instruction Manual. This warranty does not apply to any defect that R.L. DRAKE LLC determines is due to:

- (1) Improper maintenance or repair, including the installation of parts or accessories that do not conform to the quality and specifications of the original parts.
- (2) Misuse, abuse, neglect or improper installation.
- (3) Accidental or intentional damage.

All implied warranties, if any, including warranties of merchantability and fitness for a particular purpose, terminate three (3) years from the date of the original purchase.

The foregoing constitutes R.L. DRAKE LLC entire obligation with respect to this product, and the original purchaser shall have no other remedy and no claim for incidental or consequential damages, losses or expenses. Some states do not allow limitations on how long an implied warranty lasts or do not allow the exclusions or limitation of incidental or consequential damages, so the above limitation and exclusion may not apply to you.

This warranty gives you specific legal rights and you may also have other rights which vary from state to state. This warranty shall be construed under the laws of Ohio.

For Service, contact:

R.L. DRAKE LLC
230 Industrial Drive
Franklin, Ohio 45005 U.S.A.
Customer Service and Parts Telephone: +1 (937) 746-6990
Telefax: +1 (937) 806-1576
World Wide Web Site: <http://www.rldrake.com>



R.L. Drake LLC

230 Industrial Drive

Franklin, Ohio 45005 U.S.A.

Customer Service and Parts Telephone: +1 (937) 746-6990

Telefax: +1 (937) 806-1576

World Wide Web Site: <http://www.rldrake.com>