



*AC1686 Active Combiner*

---

# ***Instruction Manual***

## ii Caution Statements

WARNING: TO PREVENT FIRE OR ELECTRICAL SHOCK DO NOT EXPOSE TO RAIN OR MOISTURE



A product and cart combination should be moved with care. Quick stops, excessive force and uneven surfaces may cause the product and cart combination to overturn.



The lightning flash with arrow head symbol, within an equilateral triangle, is intended to alert the user to the presence of uninsulated "dangerous voltage" within the product's enclosure that may be of sufficient magnitude to constitute a risk of electric shock to persons.



The exclamation point within an equilateral triangle is intended to alert the user to the presence of important operating and maintenance (servicing) instructions in the literature accompanying the product.

**WARNING:** TO REDUCE THE RISK OF FIRE OR ELECTRIC SHOCK, DO NOT EXPOSE THIS PRODUCT TO RAIN OR MOISTURE. DO NOT OPEN THE CABINET, REFER SERVICING TO QUALIFIED PERSONNEL ONLY.

**CAUTION:** TO PREVENT ELECTRIC SHOCK, DO NOT USE THIS (POLARIZED) PLUG WITH AN EXTENSION CORD RECEPTACLE OR OTHER OUTLET UNLESS THE BLADES CAN BE FULLY INSERTED TO PREVENT BLADE EXPOSURE.

**ATTENTION:** POUR PREVENIR LES CHOCS ELECTRIQUES, NE PAS UTILISER CETTE FICHE POLARISEE AVEC UN PROLONGATEUR, UNE PRISE DE COURANT OU UNE AUTRE SORTIE DE COURANT, SAUF SI LES LAMES PEUVENT ETRE INSEREES A FOND SANS EN LAISSER AUCUNE PARTIE A DECOUVERT.

## Important Safety Instructions

**1. Read Instructions**—All the safety and operating instructions should be read before the product is operated.

**2. Retain Instructions**—The safety and operating instructions should be retained for future reference.

**3. Heed Warnings**—All warnings on the product and in the operating instructions should be adhered to.

**4. Follow Instructions**—All operating and use instructions should be followed.

**5. Cleaning**—Unplug this product from the wall outlet before cleaning. Do not use liquid cleaners or aerosol cleansers. Use a damp cloth for cleaning.

**6. Attachments**—Do not use attachments that are not recommended by the product manufacturer as they may cause hazards.

**7. Water and Moisture**—Do not use this product near water—for example, near a bathtub, wash bowl, kitchen sink or laundry tub; in a wet basement; or near a swimming pool; and the like.

**8. Accessories**—Do not place this product on an unstable cart, stand, tripod, bracket, or table. The product may fall, causing serious injury to a child or adult, and serious damage to the product. Use only with a cart, stand, tripod, bracket, or table recommended by the manufacturer, or sold with the product. Any mounting of the product should follow the manufacturer's instructions, and should use a mounting accessory recommended by the manufacturer.

**9.** A product and cart combination should be moved with care. Quick stops, excessive force, and uneven surfaces may cause the product and cart combination to overturn.

**10. Ventilation**—Slots and openings in the cabinet are provided for ventilation and to ensure reliable operation of the product and to protect it from overheating, and these openings must not be blocked or covered. The openings should never be blocked by placing the product on a bed, sofa, rug, or similar surface. This product should not be placed in a built-in installation such as bookcase or rack unless proper ventilation is provided or the manufacturer's instructions have been adhered to.

**11. Power Sources**—This product should be operated only from the type of power source indicated on the marking label. If you are not sure of the type of power supplied to your home, consult your product dealer or local power company. For products intended to operate from battery power, or other sources, refer to the operating instructions.

**12. Grounding or Polarization**—This product may be equipped with a polarized alternating-current line plug (a plug having one blade wider than the other). This plug will fit into the power outlet only one way. This is a safety feature. If you are unable to insert the plug fully into the outlet, try reversing the plug. If the plug should still fail to fit, contact your electrician to replace your obsolete outlet. Do not defeat the safety purpose of the polarized plug.

**Alternate Warnings**—If this product is equipped with a three-wire grounding-type plug, a plug having a third (grounding) pin, the plug will only fit into a grounding-type power outlet. This is a safety feature. If you are unable to insert the plug into the outlet, contact your electrician to replace your obsolete outlet. Do not defeat the safety purpose of the grounding-type plug.

**12 a. Mise à la terre ou Polarisation**—Cet appareil est équipé avec un cordon d'alimentation à trois fils. Il est à brancher sur une prise ayant un connecteur à la terre. Assurez-vous que la connection à la terre ne manque pas.

**13. Power-Cord Protection**—Power-supply cords should be routed so that they are not likely to be walked on or pinched by items placed upon or against them, paying particular attention to cords at plugs, convenience receptacles, and the point where they exit from the product.

**14. Outdoor Antenna Grounding**—If an outside antenna or cable system is connected to the product, be sure the antenna or cable system is grounded so as to provide some protection against voltage surges and built-up static charges. Article 810 of the National Electrical Code, ANSI/NFPA 70, provides information with regard to proper grounding of the mast and supporting structure, grounding of the lead-in wire to an antenna discharge unit, size of grounding conductors, location of antenna-discharge unit, connection to grounding electrodes, and requirements for the grounding electrode. See Figure A.

**15. Lightning**—For added protection for this product during a lightning storm, or when it is left unattended and unused for long periods of time, unplug it from the wall outlet and disconnect the antenna or cable system. This will prevent damage to the product due to lightning and power-line surges.

**16. Power Lines**—An outside antenna system should not be located in the vicinity of overhead power lines, other electric light or power circuits, where it can fall into such power lines or circuits. When installing an outside antenna system, extreme care should be taken to keep from touching such power lines or circuits as contact with them may be fatal.

**17. Overloading**—Do not overload wall outlets, extension cords, or integral convenience receptacles as this can result in a risk of fire or electric shock.

**18. Object and Liquid Entry**—Never push objects of any kind into this product through openings as they may touch dangerous voltage points or short-out parts that could result in a fire or electric shock. Never spill liquid of any kind on the product.

**19. Servicing**—Do not attempt to service this product yourself as opening or removing covers may expose you to dangerous voltage or other hazards. Refer all servicing to qualified service personnel.

**20. Damage Requiring Service**—Unplug this product from the wall outlet and refer servicing to qualified service personnel under the following conditions:

a. When the power-supply cord or plug is damaged,

b. If liquid has been spilled, or objects have fallen into the product,

c. If the product has been exposed to rain or water,

d. If the product does not operate normally by following the operating instructions. Adjust only those controls that are covered by the operating instructions as an improper adjustment of other controls may result in damage and will often require extensive work by a qualified technician to restore the product to its normal operation,

e. If the product has been dropped or damaged in any way, and

f. When the product exhibits a distinct change in performance—this indicates a need for service.

**21. Replacement Parts**—When replacement parts are required, be sure the service technician has used replacement parts specified by the manufacturer or have the same characteristics as the original part. Unauthorized substitutes may result in fire, electric shock or other hazards.

**22. Safety Check**—Upon completion of any service or repairs to this product, ask the service technician to perform safety checks to determine that the product is in proper operating condition.

**23. Wall or Ceiling Mounting**—The product should be mounted to a wall or ceiling only as recommended by the manufacturer.

**24. Heat**—The product should be situated away from heat sources such as radiators, heat registers, stoves, or other products (including amplifiers) that produce heat.

### NOTE TO CATV SYSTEM INSTALLERS:

THIS REMINDER IS PROVIDED TO CALL THE CATV SYSTEM INSTALLER'S ATTENTION TO ARTICLE 820 - 40 OF THE NEC THAT PROVIDES GUIDELINES FOR PROPER GROUNDING AND, IN PARTICULAR, SPECIFIES THAT THE CABLE GROUND SHALL BE CONNECTED TO THE GROUNDING SYSTEM OF THE BUILDING, AS CLOSE TO THE POINT OF CABLE ENTRY AS PRACTICAL.

### EXAMPLE OF ANTENNA GROUNDING

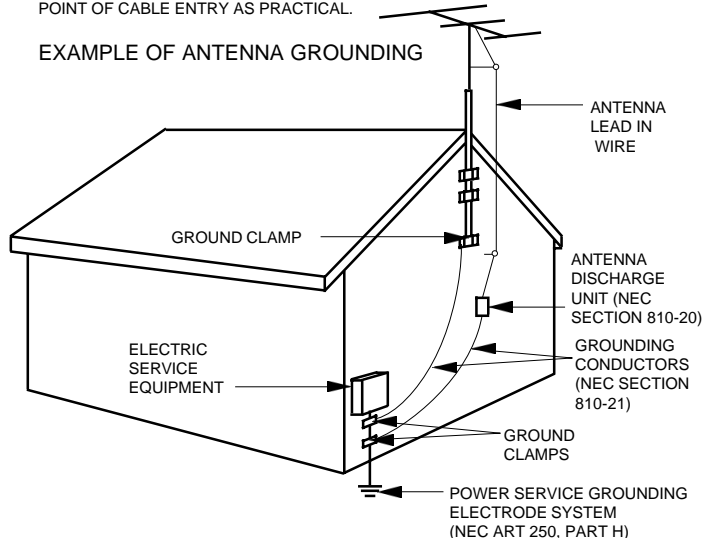

## TABLE OF CONTENTS

- |  |  |
|--|--|
| <ul style="list-style-type: none"> <li>ii. <b>Caution Statements</b></li> <li>ii. <b>Important Safety Instructions</b></li> <li>iii. <b>Table of Contents / Specifications</b></li> <li>iii. <b>General Description</b></li> </ul> | <ul style="list-style-type: none"> <li>2. <b>Front and Rear Panel Connections and Controls</b></li> <li>3. <b>Installation - Applications</b></li> <li>4. <b>Service / If You Need To Call For Help</b></li> <li>5. <b>Warranty</b></li> </ul> |
|--|--|

## SPECIFICATIONS

<p>Bandwidth: 54 - 860 MHz</p> <p>Number of Inputs: 16.</p> <p>Input Impedance: 75 Ohms (type F connectors).</p> <p>Input Return Loss: 14 dB, typical.</p> <p>Input-Input Isolation: 30 dB minimum, 54 - 550 MHz. 25 dB minimum, 550 - 860 MHz.</p> <p>Gain (any input to output): 3 dB typical, 0 dB minimum, 54 - 550 MHz. 2 dB typical, -1 dB minimum, 550 - 860 MHz.</p> <p>Input Adjustable Attenuator: Front panel setting, 15 dB minimum range.</p> <p>Maximum Input Level: +60 dBmV (input attenuator set to limit output level to rated maximum), each input.</p>	<p>Maximum Output Level: +48 dBmV each video carrier with 16 equal input NTSC signals.</p> <p>Composite Triple Beat: -60 dBc, 16 channels at output level of +48 dBmV per channel.</p> <p>Cross Modulation: -60 dBc, 16 channels at output level of +48 dBmV per channel.</p> <p>Output Return Loss: 14 dB, typical.</p> <p>Output Test Point: -20 dB <math>\pm</math> 2 dB.</p> <p>Power Requirements: 14 VAC/700 mA supplied by included AC adapter.</p> <p>AC Adapter Input: 120 VAC/60 Hz.</p> <p>Operating Temperature: 0° C to 50° C, ambient.</p> <p>Size: 19" W x 1.75" H x 4.0" D.</p> <p>Weight: 4 Lbs.</p>
--	---

## GENERAL DESCRIPTION

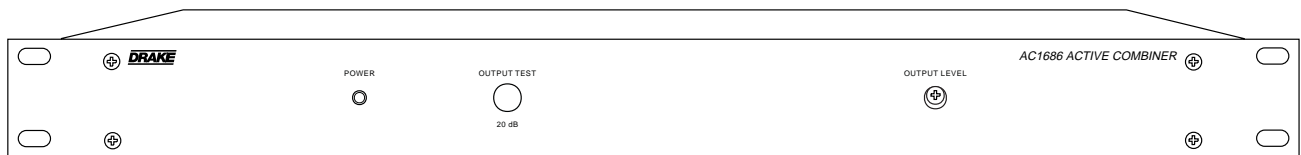

The AC1686 Active Combiner permits combining the outputs of up to 16 Audio/Video Modulators, Channel Processors, etc. onto a single coax. The unit includes a low distortion Ga As output amplifier to permit linear signal output and very low input noise figure.

The AC1686 is housed in a standard 1-3/4" H x 19" W rack space. A monitor output is provided at the front panel of the combiner.

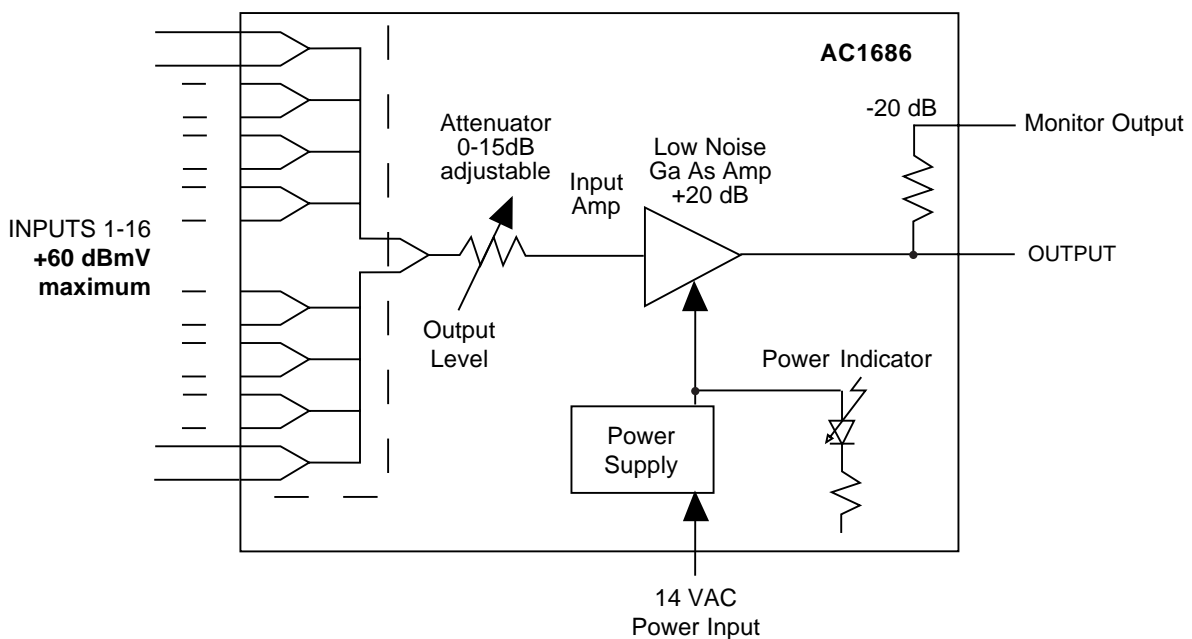

**AC1686 BLOCK DIAGRAM**

## 2 Front and Rear Panel Connections and Controls

### FRONT PANEL

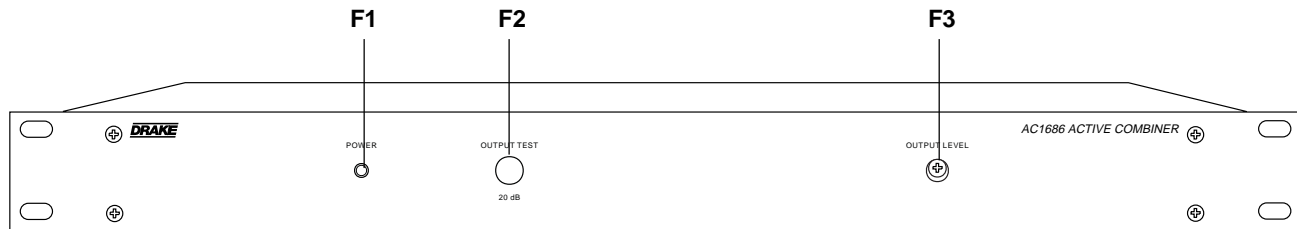

#### F1 - POWER Indicator

Lights to indicate that the combiner is connected to a source of power.

#### F2 - MONITOR Test Point Connector

This type F connector is provided for sampling the combined RF Output of the combiner. The level of each signal at this connector is approximately 20 dB below the level of the respective signal present at the rear panel 'RF OUTPUT' connector. The rear panel output connector must be terminated in 75 Ohms.

#### F3 - OUTPUT LEVEL Control

This screwdriver adjusted attenuator permits setting the attenuation of the combined signals applied to the 'INPUTS 1-16' rear panel connectors prior to amplification. The range of attenuation adjustment is at least 15 dB.

### REAR PANEL

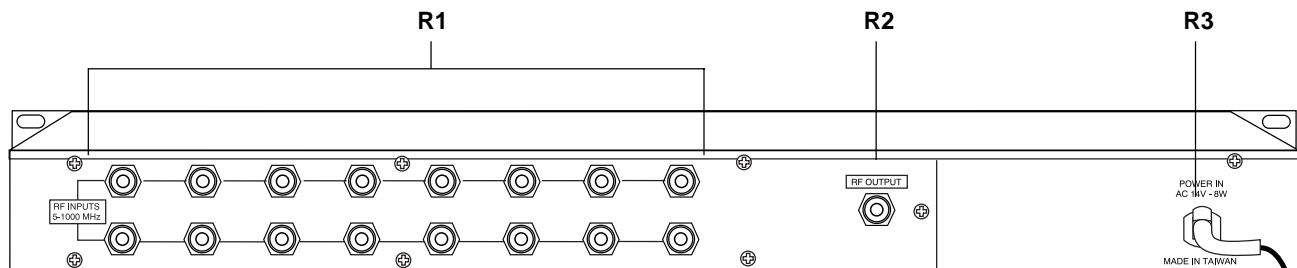

#### R1 - INPUTS 1-16 Connectors

These type F connectors accept signals with levels up to 60 dBmV each, maximum.

#### R2 - RF OUT Connector

This type F connector provides the single coax output connection of the combined signal inputs. With the front panel 'OUTPUT LEVELS 1-16' control set maximum clockwise, the signal level output is approximately 2 dB to 3 dB above the respective signal level input at the 'INPUTS 1-16' connectors.

#### R3 - POWER CABLE

When this cable is connected to the accompanying 120 VAC power adapter, and the adapter is plugged into a nominal 120 VAC power source, 14 VAC power will be supplied to the unit.

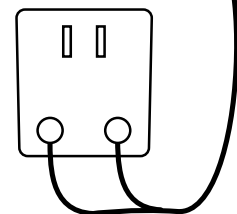

## CONNECTIONS AND CONTROLS

All connections, except the output monitor test port, to and from the AC1686, are made through the rear panel. A convenient front panel gain adjustment is also provided. The included application diagrams are drawn as Block Diagrams to more efficiently illustrate the system connections.

## INSTALLATION NOTES

Level adjustment is critical in a multichannel installation, and should be checked periodically with a spectrum analyzer or CATV signal level meter.

Care should be taken to insure that all channels are within  $\pm 1$  dB of the desired output for best adjacent channel operation. In addition, all A/V ratios should be held to -15 dB or less.

Adequate ventilation is very important in multichannel installations. Units should be spaced apart by at least one panel height, and some air movement is advisable in enclosed rack cabinets. Excessive heat will shorten component life and equipment performance will be degraded without proper cooling.

Use the following chart to determine the maximum permissible output levels for the specific number of combined input channels from 2 - 16.

If these levels are exceeded, second and third order distortion products may exceed acceptable levels.

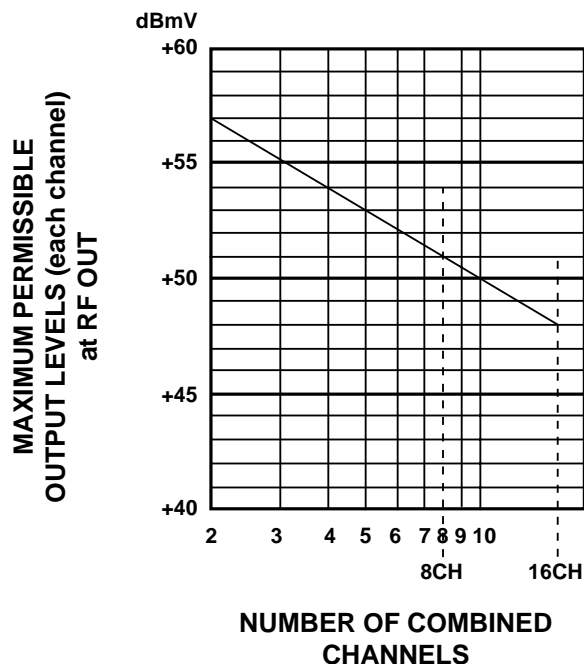

### Application Notes:

1) Use with 16 modulators with 45 dBmV output levels. Set all modulator output levels to +45 dBmV. Adjust input attenuator on the active combiner until the combiner output levels are all at the desired output level, but not exceeding 48 dBmV per channel, as measured at the combiner output port. Slightly level each modulator, as required, by adjusting each modulator output. Do not exceed maximum output levels shown in the above graph.

2) Use with 16 modulators with 55 dBmV output levels. Set all modulator output levels to +55 dBmV. For best noise performance, it is best to keep modulator outputs within 5 dB of the maximum output. Start with the active combiner attenuation adjustment at the extreme counterclockwise position and adjust to bring output levels up to desired level. Do not exceed the maximum shown in the above graph. Next, adjust individual modulator outputs slightly to equalize all channels.

## 4 Service / If You Need To Call For Help

The AC1686 Active Combiner has been designed and produced to provide trouble-free service. Should the need for repair arise, extreme caution should be used to avoid a potentially lethal electric shock.

FUSE: The power transformer is internally fused.

In the rare case that this fuse is blown, the transformer must be replaced.

There are no internal adjustments that can be made in the field. Any circuit element changes require sophisticated test equipment, and checkout should be attempted only by a trained technician.

---

### SERVICE INFORMATION

You may contact the R.L. DRAKE Service Department for additional information or assistance by calling +1 (937) 746-6990, Monday through Friday, between 8:00 A.M. and 4:00 P.M. Eastern Time, except on holidays.

You may also contact the R.L. DRAKE Service Department by E-mail at the following address:  
service@rldrake.com  
or by Telefax:  
+1 (937) 743-4576.

Should you want to return your unit for service, package the unit carefully using the original carton or other suitable container.

Write your return address clearly on the shipping carton and on an enclosed cover letter describing the service required, symptoms or problems. Also include your daytime telephone number and a copy of your proof of purchase.

The unit will be serviced under the terms of the R.L. DRAKE COMPANY Limited Warranty and returned to you.

---

### IF YOU NEED TO CALL FOR HELP

Call our Customer Service/Technical Support line at +1 (937) 746-6990 between 8:00 A.M. and 4:00 P.M. Eastern Time, weekdays. Please have the unit's serial number available. We will also need to know the specifics of any other equipment connected to the unit. When calling, please have the unit up and running, near the phone if possible. Our technician(s) will likely ask certain questions to aid in diagnosis of the problem. Also, have a voltmeter handy, if possible.

R.L. DRAKE also provides technical assistance by e-mail: service@rldrake.com  
or by Telefax: +1 (937) 743-4576.

Many of the products that are sent to us for repair are in perfect working order when we receive them. For these units, there is a standard checkout fee that you will be charged. Please perform whatever steps are applicable from the installation sections of the Owner's Manual before calling or writing—this could save unnecessary phone charges. Please do not return the unit without contacting R.L. DRAKE first: it is preferred to help troubleshoot the problem over the phone (or by mail) first, saving you both time and money.

Inside the carton, enclose a note with your name, address, daytime phone number, and a description of the unit's problem.

The unit must be sent to the following address:

**Service Department  
R.L. DRAKE COMPANY  
230 Industrial Drive  
Franklin, Ohio 45005 U.S.A.**

Be sure to include your street address which will be needed for UPS return. UPS Surface (Brown Label) takes 7-10 days to reach us depending on your location, Blue takes 2-3 days.

Red is an overnight service. Send the unit in a way that it can be traced if we can't verify receipt of shipment. We suggest UPS or insured postal shipment.

If the unit is still under the original owner's warranty, R.L. DRAKE will pay the cost of the return shipment to you. Our return shipping policy is that we will return it UPS Brown if received Brown or by US Mail, it will be returned Blue if received Blue or Red—or it will be returned however you prefer if you furnish the return cost for the method you select.

If the unit is out of warranty, use one of the following methods for return shipment:

- 1) You designate billing to American ExPress, VISA, MasterCard or Discover card;
- 2) You prepay the service charges with a personal check, or
- 3) You specify some other method of return and payment.

When calling, the technician can estimate the repair charges for you over the phone. This is another good reason to call before sending a unit in for repair. Typically, equipment is repaired in five to ten working days after it arrives at R.L. DRAKE if we have all the facts. If we must call you, it may take longer. R.L. DRAKE is not responsible for damage caused by lightning, nonprofessional alterations, "acts of God", shipping damage, poor storage/handling, etc. R.L. DRAKE will make note of any shipping damage upon receipt.

Should your warranty card not be on file at R.L. DRAKE, you will need to send proof of purchase to receive warranty service. Typically, a copy of the invoice from an R.L. DRAKE dealer will suffice. The warranty is for the original owner only and is not transferable.

## Three Year Limited Warranty

R.L. DRAKE COMPANY warrants to the original purchaser this product shall be free from defects in material or workmanship for three (3) years from the date of original purchase.

During the warranty period the R.L. DRAKE COMPANY or an authorized Drake service facility will provide, free of charge, both parts and labor necessary to correct defects in material and workmanship. At its option, R.L. DRAKE COMPANY may replace a defective unit.

To obtain such a warranty service, the original purchaser must:

- (1) Retain invoice or original proof of purchase to establish the start of the warranty period.
- (2) Notify the R.L. DRAKE COMPANY or the nearest authorized service facility, as soon as possible after discovery of a possible defect, of:
  - (a) the model and serial number,
  - (b) the identity of the seller and the approximate date of purchase; and
  - (c) A detailed description of the problem, including details on the electrical connection to associated equipment and the list of such equipment.
- (3) Deliver the product to the R.L. DRAKE COMPANY or the nearest authorized service facility, or ship the same in its original container or equivalent, fully insured and shipping charges prepaid.

Correct maintenance, repair, and use are important to obtain proper performance from this product. Therefore carefully read the Instruction Manual. This warranty does not apply to any defect that R.L. DRAKE COMPANY determines is due to:

- (1) Improper maintenance or repair, including the installation of parts or accessories that do not conform to the quality and specifications of the original parts.
- (2) Misuse, abuse, neglect or improper installation.
- (3) Accidental or intentional damage.

All implied warranties, if any, including warranties of merchantability and fitness for a particular purpose, terminate three (3) years from the date of the original purchase.

The foregoing constitutes R.L. DRAKE COMPANY'S entire obligation with respect to this product, and the original purchaser shall have no other remedy and no claim for incidental or consequential damages, losses or expenses. Some states do not allow limitations on how long an implied warranty lasts or do not allow the exclusions or limitation of incidental or consequential damages, so the above limitation and exclusion may not apply to you.

This warranty gives you specific legal rights and you may also have other rights which vary from state to state. This warranty shall be construed under the laws of Ohio.

For Service, contact:

**R.L. DRAKE COMPANY**  
230 Industrial Drive  
Franklin, Ohio 45005 U.S.A.  
**Customer Service and Parts Telephone:** +1 (937) 746-6990  
**Telefax:** +1 (937) 743-4576  
**World Wide Web Site:** <http://www.rldrake.com>



**R.L. DRAKE COMPANY**  
230 INDUSTRIAL DRIVE  
FRANKLIN, OHIO 45005 U.S.A.  
**CUSTOMER SERVICE AND PARTS TELEPHONE: +1 (937) 746-6990**  
**TELEFAX: +1 (937) 743-4576**  
**WORLD WIDE WEB SITE: <http://www.rldrake.com>**